

**Republic of Botswana
Ministry of Minerals, Energy and Water Resources
Department of Water Affairs**

**Feasibility Design Study on the Utilization of the Water
Resources of the Chobe/Zambezi River**

Tender No. PR 10/3/1/09

Draft Prefeasibility/Feasibility Design Study Report

August 2010

Submitted by



P O BOX 40459
Gaborone, Botswana
Tel:3180616
Fax:3180618
Email:Wrc@wrc.bw

IN ASSOCIATION WITH



**Ninham Shand (Pty)
Ltd, South Africa**



Executive Summary

Background

The Government of Botswana (GOB), through the Ministry of Minerals, Energy and Water Resources (MMEWR), Department of Water Affairs (DWA) commissioned a study to investigate the feasibility of water abstraction from the Chobe/Zambezi River system near Kazungula/Kasane area in the Chobe District. This water is intended to be used to meet the water demands within Botswana by about 2020 for domestic purposes. However, the Ministry of Agriculture (MOA) intends to abstract Chobe/Zambezi water for irrigation development in the Pandamatenga area in the near future as per the National Agricultural Master Plan (MOA, 2000).

The review of Botswana National Water Master Plan recommended commissioning of the Chobe/Zambezi Transfer scheme by 2022 (SMEC/EHES, 2006). The proposed project will abstract 495 Million Cubic Meters (MCM) per annum from the Chobe/Zambezi River of which a great portion will be utilized for agricultural development at Pandamatenga. However, given the deficit of water that is anticipated by 2020 in the urban centres, Botswana might require more water from the Zambezi River in future. On this basis, Botswana would require implementation of the Chobe/Zambezi water transfer scheme by 2011-2020. It is foreseen that the proposed water transfer scheme will link up with the existing North-South Carrier Water Pipeline.

The Southern African Development Community (SADC) has developed a Protocol on Shared Watercourses with the latest revision signed at Windhoek, Namibia in 2000. The Protocol provides a framework for closer cooperation for prudent, sustainable and coordinated management, protection and utilization of shared watercourses. The Zambezi River basin states are all members of SADC and have agreed to a Joint Integrated Water Resources Management Strategy (IWRMS) under the Zambezi Action Plan (ZACPLAN). Among others, the strategy aims at establishing the Zambezi Watercourse Commission (ZAMCOM). ZAMCOM is responsible for the shared aspects of Operational Water Resources Management.

Botswana submitted a formal request to the Zambezi Member States of its intention to abstract 495 MCM per annum of water from the Zambezi River at the SADC Ministers of Water Meeting held in Maputo, Mozambique from 6 – 9 July 2009. This has been discussed at various meetings of the ZAMCOM, and to date no objections have been raised by the other member states.

Pre-Feasibility Overview

The pipeline that will supply water for domestic purposes starts at the end-point reservoir at Pandamatenga and ends at Break Pressure Tank 1, west of Selebi-Phikwe, with future plans of eventually joining the North-South Carrier Pipeline. In this report two alternative routes were identified and evaluated in the development of a long term, reliable water supply from the Chobe/Zambezi river system. Different pipeline configurations, hydraulic analysis and cost estimates were carried out to achieve the most effective design of the transfer system.

Route 1 (R1) starts at Pandamatenga Stage 2 Reservoir; runs through Serule and flows into Break Pressure Tank (BPT) 1. Route 2 (R2) also starts at Pandamatenga but flows straight into BPT1. R1 is longer than R2 and therefore has a higher capital cost. The terrain along this route is also higher than R2. Economically R2 is the better option. The net present values of options along R1 are higher than those along R2. However, selecting R1 gives an advantage of supplying water to Serule. In both routes various pumping options are considered for selecting the best pumping strategy. Options 3, 4 and 6 have multiple pump stations. The advantage of multiple pump stations is that lower pressure class pipes can be used resulting in significant savings. Lower head pumps are less subject to wear especially if there is sediment in the water. The overall cost of multiple pump stations, including cost of power to the various sites, access roads and cost of equipment must be considered for option selection.

Options 2, 3, 4 and 6 have break pressure tanks. These reservoirs will give an advantage of supplying water when there is an interruption of flow from the transmission main and provide supplemental water during peak periods. The reservoirs will sectionalize the pipe to reduce mean pressures and transmission pressures. If an uninterrupted supply is desired, options with reservoirs must be considered because large fluctuations in demand can be tolerated in such systems. Options 1 and 5 do not have additional reservoirs; therefore these systems must be designed in such a way that there will be continuous adjustment of the flow within safe pressure limits.

Option Comparison

*The 12 options analysed in the Life Cycle Cost Analysis (LCCA) can be compared directly using their calculated Net Present Values (NPVs). These values were calculated using the same methodology and input values. The options with the lowest NPVs will be the most economical options over the entire project lifetime and therefore the most preferable option. The options are compared graphically in **Figure 1** and in tabular format in **Table 1**.*

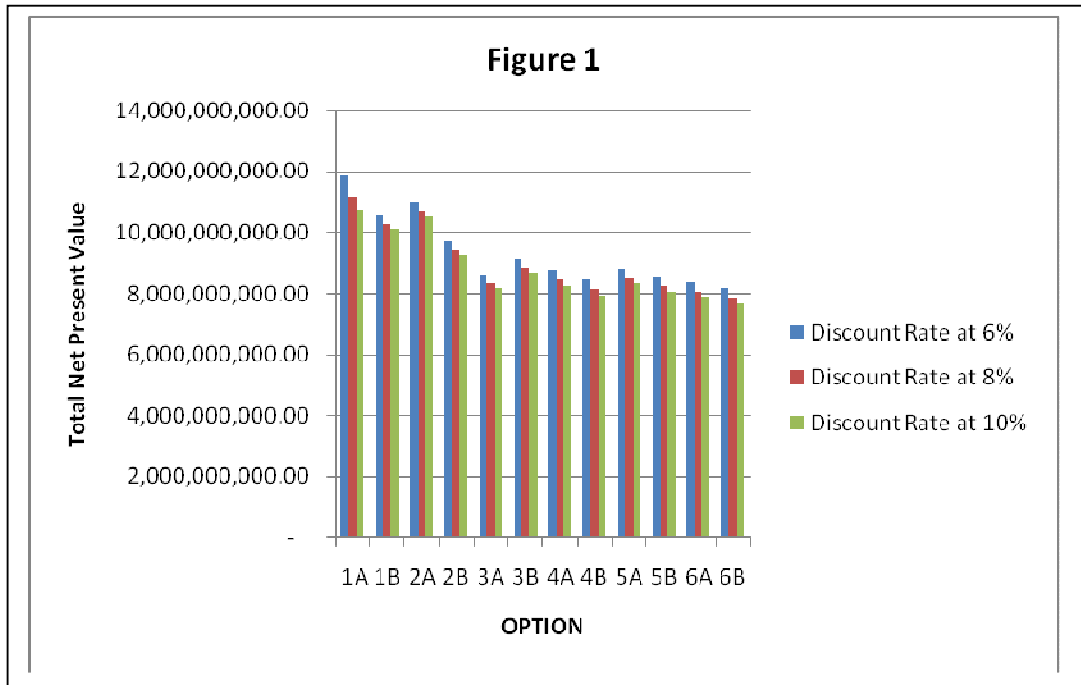

Figure 1: Net Present Values

Table 2: Net Present Values

OPTION	Discount Rate at 6%	Discount Rate at 8%	Discount Rate at 10%
1A	11,856,000,000.00	11,127,000,000.00	10,733,000,000.00
1B	10,572,000,000.00	10,277,000,000.00	10,095,000,000.00
2A	10,994,000,000.00	10,693,000,000.00	10,507,000,000.00
2B	9,725,000,000.00	9,456,000,000.00	9,290,000,000.00
3A	8,588,000,000.00	8,329,000,000.00	8,168,000,000.00
3B	9,140,000,000.00	8,862,000,000.00	8,690,000,000.00
4A	8,758,000,000.00	8,448,000,000.00	8,257,000,000.00
4B	8,445,000,000.00	8,143,000,000.00	7,956,000,000.00
5A	8,823,000,000.00	8,513,000,000.00	8,320,000,000.00
5B	8,557,000,000.00	8,252,000,000.00	8,063,000,000.00
6A	8,371,000,000.00	8,070,000,000.00	7,884,000,000.00
6B	8,176,000,000.00	7,864,000,000.00	7,672,000,000.00

From these comparisons it is noted that the options including break pressure reservoirs are considerably more economical than those without. This highlights the fact that the comparison of the options is governed by the cost of the construction of

the steel pipeline and specifically to the cost of the steel pipeline with regards to its pipe wall thickness as the pipeline extends over a long distance.

Conclusion & Recommendations

Option 6A and Option 6B have the lowest Net Present Values and are the preferred options. The NPV of Option 6A is higher than that of Option 6B; this is due to the increased cost resulting from the longer pipeline length. Depending on conditions of the pipeline and the necessity of the pipeline to pass Serule Option 6B is the recommended option and therefore R2 is the recommended route. Option 6B is discussed in greater detail in Option 6B Details and Recommendations. If water is to be supplied to Serule then Option 6A will be the recommended option.

It is recommended that Option 6 be optimised in a detailed feasibility study. Apart from the technical issues discussed above, the economical advantage to construct the pipeline in two or more phases needs to be investigated.

TABLE OF CONTENTS

1. INTRODUCTION.....1-1

1.1 BACKGROUND.....1-1

1.2 PROJECT STATUS.....1-2

2. PRE-FEASIBILITY OVERVIEW2-1

2.1 METHODOLOGY2-4

2.2 OPTION DESCRIPTION.....2-4

3. DESIGN AND CALCULATION CRITERIA3-9

3.1 PIPELINE DESIGN CRITERIA3-9

3.2 PUMP STATION DESIGN CRITERIA3-9

3.3 OPERATION PHILOSOPHY3-10

3.4 LIFE CYCLE COSTING CRITERIA3-11

4. OPTION ANALYSES.....4-13

4.1 GENERAL.....4-13

4.2 OPTION 1A.....4-13

4.3 OPTION 1B.....4-19

4.4 OPTION 2A.....4-24

4.5 OPTION 2B.....4-29

4.6 OPTION 3A.....4-34

4.7 OPTION 3B.....4-38

4.8 OPTION 4A.....4-43

4.9 OPTION 4B.....4-47

4.10 OPTION 5A.....4-52

4.11 OPTION 5B.....4-57

4.12 OPTION 6A.....4-62

4.13 OPTION 6B4-68

4.14 OPTION COMPARISON.....4-74

5. CONCLUSION5-1

5.1 OPTION 6B DETAILS AND RECOMMENDATIONS5-1

5.2 FURTHER PROJECT PHASES5-1

6. RECOMMENDATION6-1

7. APPENDICES.....7-1

LIST OF FIGURES

FIGURE 1-1:	WATER DEMAND PROJECTION.....	1-3
FIGURE 2-1:	PIPELINE ROUTE	2-2
FIGURE 2-2:	ALTERNATIVE ROUTE.....	2-2
FIGURE 2-3:	CONTROL POINTS	2-4
FIGURE 2-4:	OPTION 1 CONTROL POINTS.....	2-5
FIGURE 2-5:	OPTION 2 CONTROL POINTS.....	2-5
FIGURE 2-6:	OPTION 3 CONTROL POINTS.....	2-6
FIGURE 2-7:	OPTION 4 CONTROL POINTS.....	2-7
FIGURE 2-8:	OPTION 5 CONTROL POINTS.....	2-7
FIGURE 2-9:	OPTION 6 CONTROL POINTS.....	2-8
FIGURE 4-1:	PRE-FEASIBILITY STUDY LONGITUDINAL PROFILE	4-13
FIGURE 4-2:	OPTION 1A MFD	4-16
FIGURE 4-3:	OPTION 1A LONGITUDINAL AND ENERGY PROFILE	4-17
FIGURE 4-4:	OPTION 1B MFD	4-21
FIGURE 4-5:	OPTION 1B LONGITUDINAL AND ENERGY PROFILE	4-22
FIGURE 4-6:	OPTION 2A MFD	4-26
FIGURE 4-7:	OPTION 2A LONGITUDINAL AND ENERGY PROFILE	4-26
FIGURE 4-8:	OPTION 2B MFD	4-30
FIGURE 4-9:	OPTION 2B LONGITUDINAL AND ENERGY PROFILE	4-32
FIGURE 4-10:	OPTION 3A MFD	4-36
FIGURE 4-11:	OPTION 3A LONGITUDINAL AND ENERGY PROFILE	4-36
FIGURE 4-12:	OPTION 3B MFD	4-39
FIGURE 4-13:	OPTION 3B LONGITUDINAL AND ENERGY PROFILE	4-41
FIGURE 4-14:	OPTION 4A MFD	4-45
FIGURE 4-15:	OPTION 4A LONGITUDINAL AND ENERGY PROFILE	4-45
FIGURE 4-16:	OPTION 4B MFD	4-49
FIGURE 4-17:	OPTION 4B LONGITUDINAL AND ENERGY PROFILE	4-50
FIGURE 4-18:	OPTION 5A MFD	4-54
FIGURE 4-19:	OPTION 5A LONGITUDINAL AND ENERGY PROFILE	4-55
FIGURE 4-20:	OPTION 5B MFD	4-59
FIGURE 4-21:	OPTION 5B LONGITUDINAL AND ENERGY PROFILE	4-60
FIGURE 4-22:	OPTION 6A MFD	4-64
FIGURE 4-23:	OPTION 6A LONGITUDINAL AND ENERGY PROFILE	4-66
FIGURE 4-24:	OPTION 6B MFD	4-71
FIGURE 4-25:	OPTION 6B LONGITUDINAL AND ENERGY PROFILE	4-71
FIGURE 4-26:	NET PRESENT VALUE COMPARISON.....	4-74

LIST OF TABLES

TABLE 2-1:	PRE-FEASIBILITY OPTIONS.....	2-8
TABLE 3-1:	BOTSWANA PUMP STATION ENERGY TARIFFS	3-11
TABLE 4-1:	OPTION 1A HYDRAULIC COMPONENTS	4-14
TABLE 4-2:	OPTION 1A CAPITAL COSTS	4-14
TABLE 4-3:	OPTION 1A ANNUAL MAINTENANCE COSTS.....	4-14
TABLE 4-4:	OPTION 1A ENERGY COSTS SUMMARY.....	4-15
TABLE 4-5:	OPTION 1A LIFE CYCLE COSTING	4-17
TABLE 4-6:	OPTION 1B HYDRAULIC COMPONENTS	4-19

TABLE 4-7:	OPTION 1B CAPITAL COSTS	4-20
TABLE 4-8:	OPTION 1B ANNUAL MAINTENANCE COSTS	4-20
TABLE 4-9:	OPTION 1B ENERGY COSTS SUMMARY.....	4-20
TABLE 4-10:	OPTION 1B LIFE CYCLE COSTING	4-22
TABLE 4-11:	OPTION 2A HYDRAULIC COMPONENTS	4-24
TABLE 4-12:	OPTION 2A CAPITAL COSTS	4-25
TABLE 4-13:	OPTION 2A MAINTENANCE COSTS	4-25
TABLE 4-14:	OPTION 2A ENERGY COSTS SUMMARY.....	4-25
TABLE 4-15:	OPTION 2A LIFE CYCLE COSTING	4-27
TABLE 4-16:	OPTION 2B HYDRAULIC COMPONENTS	4-29
TABLE 4-17:	OPTION 2B CAPITAL COSTS	4-30
TABLE 4-18:	OPTION 2B MAINTENANCE COSTS	4-30
TABLE 4-19:	OPTION 2B ENERGY COSTS SUMMARY.....	4-30
TABLE 4-20:	OPTION 2B LIFE CYCLE COSTING	4-32
TABLE 4-21:	OPTION 3A HYDRAULIC COMPONENTS	4-34
TABLE 4-22:	OPTION 3A CAPITAL COSTS	4-35
TABLE 4-23:	OPTION 3A MAINTENANCE COSTS	4-35
TABLE 4-24:	OPTION 3A ENERGY COSTS SUMMARY.....	4-35
TABLE 4-25:	OPTION 3A LIFE CYCLE COSTING	4-37
TABLE 4-26:	OPTION 3B HYDRAULIC COMPONENTS	4-39
TABLE 4-27:	OPTION 3B CAPITAL COSTS	4-39
TABLE 4-28:	OPTION 3B MAINTENANCE COSTS	4-39
TABLE 4-29:	OPTION 3B ENERGY COSTS SUMMARY.....	4-39
TABLE 4-30:	OPTION 3B LIFE CYCLE COSTING	4-41
TABLE 4-31:	OPTION 4A HYDRAULIC COMPONENTS	4-43
TABLE 4-32:	OPTION 4A CAPITAL COSTS	4-44
TABLE 4-33:	OPTION 4A MAINTENANCE COSTS	4-44
TABLE 4-34:	OPTION 4A ENERGY COSTS SUMMARY.....	4-44
TABLE 4-35:	OPTION 4A LIFE CYCLE COSTING	4-46
TABLE 4-36:	OPTION 4B HYDRAULIC COMPONENTS	4-48
TABLE 4-37:	OPTION 4B CAPITAL COSTS.....	4-48
TABLE 4-38:	OPTION 4B MAINTENANCE COSTS	4-49
TABLE 4-39:	OPTION 4B ENERGY COSTS SUMMARY.....	4-49
TABLE 4-40:	OPTION 4B LIFE CYCLE COSTING	4-50
TABLE 4-41:	OPTION 5A HYDRAULIC COMPONENTS	4-52
TABLE 4-42:	OPTION 5A CAPITAL COSTS	4-53
TABLE 4-43:	OPTION 5A MAINTENANCE COSTS	4-53
TABLE 4-44:	OPTION 5A ENERGY COSTS SUMMARY.....	4-53
TABLE 4-45:	OPTION 5A LIFE CYCLE COSTING	4-55
TABLE 4-46:	OPTION 5B HYDRAULIC COMPONENTS	4-57
TABLE 4-47:	OPTION 5B CAPITAL COSTS	4-58
TABLE 4-48:	OPTION 5B MAINTENANCE COSTS	4-58
TABLE 4-49:	OPTION 10 ENERGY COSTS SUMMARY	4-58
TABLE 4-50:	OPTION 5B LIFE CYCLE COSTING	4-60
TABLE 4-51:	OPTION 6A HYDRAULIC COMPONENTS	4-63
TABLE 4-52:	OPTION 6A CAPITAL COSTS	4-63
TABLE 4-53:	OPTION 6A MAINTENANCE COSTS	4-64
TABLE 4-54:	OPTION 6A ENERGY COSTS SUMMARY.....	4-64

TABLE 4-55:	OPTION 6A LIFE CYCLE COSTING	4-66
TABLE 4-56:	OPTION 6B HYDRAULIC COMPONENTS	4-68
TABLE 4-57:	OPTION 6B CAPITAL COSTS	4-69
TABLE 4-58:	OPTION 6B MAINTENANCE COSTS	4-69
TABLE 4-59:	OPTION 6B ENERGY COSTS SUMMARY.....	4-70
TABLE 4-60:	OPTION 6B LIFE CYCLE COSTING	4-72
TABLE 4-61:	NET PRESENT VALUE COMPARISON.....	4-75

APPENDICES

APPENDIX A: BOTSWANA POWER CORPORATION (BPC) TARIFFS

APPENDIX B: LIFE CYCLE COST ANALYSIS COST ESTIMATES

APPENDIX C: OPTION 6B PIPE WALL THICKNESS CALCULATION SHEET

GLOSSARY OF ACRONYMS AND ABBREVIATIONS

AADD	Average Annual Daily Demand
BNWMPR	Botswana National Water master Plan Review
BPC	Botswana Power Corporation
BPT	Break Pressure Tank
BTC	Botswana Telecommunications Corporation
BWP	Botswana Pula
CD	Compact Disc
CDC	Central District Council
CESMM	Civil Engineering Standard Method of Measurement
CSO	Central Statistics Office
DEA	Department of Environmental Affairs
DCP	Department of Crop Production
DSM	Department of Survey and Mapping
DTM	Digital Terrain Model
DWA	Department of Water Affairs
EIA	Environmental Impact Assessment
GOB	Government of Botswana
GPS	Global Positioning System
HGL	Hydraulic Grade Line
IRR	Internal Rate of Return
IS	Information System
ISO	International Standards Organisation
IWRM	Integrated Water Resources Management
IWRMS	Integrated Water Resources Management Strategy
Kg/m ³	Kilogramme per metre cubed
Km	Kilometre
Km ²	Square Kilometre
Km ²	Square Kilometre
kPa	Kilo-Pascal
LCCA	Life Cycle Cost Analysis
Ltd.	Limited
MDF	Mechanical Flow Diagrams
MMEWR	Ministry of Minerals, Energy and Water Resources
MOA	Ministry of Agriculture
M ²	Square Meter
M ³ /a	Cubic Meters per Annum
M ³ /s	Cubic Meters per Second
MCM	Million Cubic Metres
NAMP	National Agriculture Master Plan
NAMPAAD	National Master Plan for Arable Agriculture and Dairy Development
NGL	Natural Ground Level
No.	Number

NPV	Net Present Value
NSC	North South Carrier Water Project
O&M	Operation and Maintenance
OWRM	Operational Water Resources Management
P_f	Peak Factor
PDF	Peak Demand Flow
R1	Pipeline Route 1
R2	Pipeline Route 2
RSA	Republic of South Africa
PS	Pump Station
SABS	South African Bureau of Standards
SADC	Southern African Development Community
SCADA	Supervisory Control and Data Acquisition
US	United States Dollar
uPVC	Unplasticised Polyvinyl Chloride
Ver.	Version
VO	Variation Order
WDM	Water Demand Model
WRC	Water Resources Consultants (Pty) Ltd
WTW	Water Treatment Works
WUC	Water Utilities Corporation
ZACPLAN	Zambezi Action Plan
ZAMCOM	Zambezi Watercourse Commission
ZAR	South African Rand
4 x 4	Four Wheel Drive

1. INTRODUCTION

1.1 BACKGROUND

The Government of Botswana (GOB), through the Ministry of Minerals, Energy and Water Resources (MMEWR), Department of Water Affairs (DWA) commissioned a study to investigate the feasibility of water abstraction from the Chobe/Zambezi River system near Kazungula/Kasane area in the Chobe District. This water is intended to be used to meet the water demands within Botswana by about 2020 for domestic purposes. However, the Ministry of Agriculture (MOA) intends to abstract Chobe/Zambezi water for irrigation development in the Pandamatenga area in the near future as per the National Agricultural Master Plan (MOA, 2000).

The review of Botswana National Water Master Plan recommended commissioning of the Chobe/Zambezi Transfer scheme by 2022 (SMEC/EHES, 2006). Botswana requires about 495 million m³/a (15.7 m³/s) from the Zambezi River for agricultural purposes, mainly for the Zambezi Integrated Agro-Commercial Development Project. However, given the deficit of water that is anticipated by 2020 in the urban centres, Botswana might require more water from the Zambezi River in future. On this basis, Botswana would require implementation of the Chobe/Zambezi water transfer scheme by 2011-2020. It is foreseen that the proposed water transfer scheme will link up with the existing North-South Carrier Water Project.

Botswana is a member of the Southern African Development Community (SADC). SADC has developed a Protocol on Shared Watercourses with the latest revision signed at Windhoek, Namibia in 2000. The Protocol provides a framework for closer cooperation for prudent, sustainable and coordinated management, protection and utilization of shared watercourses. The Zambezi River basin states are all members of SADC and have agreed to a Joint Integrated Water Resources Management Strategy (IWRMS) under the Zambezi Action Plan (ZACPLAN). Among others, the strategy aims at establishing the Zambezi Watercourse Commission (ZAMCOM). ZAMCOM is responsible for the shared aspects of Operational Water Resources Management. It is imperative for Botswana to urgently undertake this study so that other riparian states could make informed decisions on how much water should be allocated to Botswana.

Botswana submitted a formal request to ZAMCOM of its intention to abstract 495 MCM per annum of water from the Zambezi River at the SADC Ministers of Water Meeting held in Maputo, Mozambique from 6 – 9 July 2009. This has been discussed at various meetings of the ZAMCOM, and to date no objections have been raised by the other member states.

The project will essentially consist of two parts and two phases. The first part of the project will deliver water to the Pandamatenga area for irrigation and other

agricultural activities. The second part will convey water for domestic demands from the Pandamatenga area southward to the North-South Carrier Pipeline (NSC) which will convey water to Gaborone. Both parts will be developed in two phases.

Water Resources Consultants, ILISO Consulting and Ninham Shand were awarded the pre-feasibility/feasibility study for the second part of the project, i.e. from Pandamatenga to Break Pressure Tank No. 1 (BPT1) located near Moralane in the Central District.

1.2 PROJECT STATUS

The Consultant submitted the interim water demand report to the DWA on 22 April 2010 in order to confirm with all stakeholders that the projected water demand figures that would be used in the investigation were correct. The interim water demand report was approved and accepted by the DWA and the recommendations (based on the 2035-65 water demand projections) are as follows:

- The pipeline to be designed from Pandamatenga up to Break Pressure Tank No. 1 especially as backup in case of droughts (prior to 2035).
- Draw-off from pipeline to supply Selebi-Phikwe and other smaller communities to be provided.
- The pipeline to be designed and planned in phases according to increasing water demands.
- The pipeline to be in operation as from 2024.
- Maintenance (e.g. dredging operations) planning to be done especially for Letsibogo, Shashe and Dikgatlong dams.

Figure 1-1 below shows the projected water requirements from the Zambezi River which will be used in this report to investigate various configurations.

The full design capacity of the transfer scheme is 100 million m³/a, which is the projected water demand in 2062. Although this is a few years short of the target of 2065, it is equal to the volume that has been allocated for urban supply from the Zambezi River, and the 3 years difference is not significant in terms of the feasibility study and the margin of error surrounding the demand projections. The projected increase in water demand will be used to determine the life-cycle costs of the project.

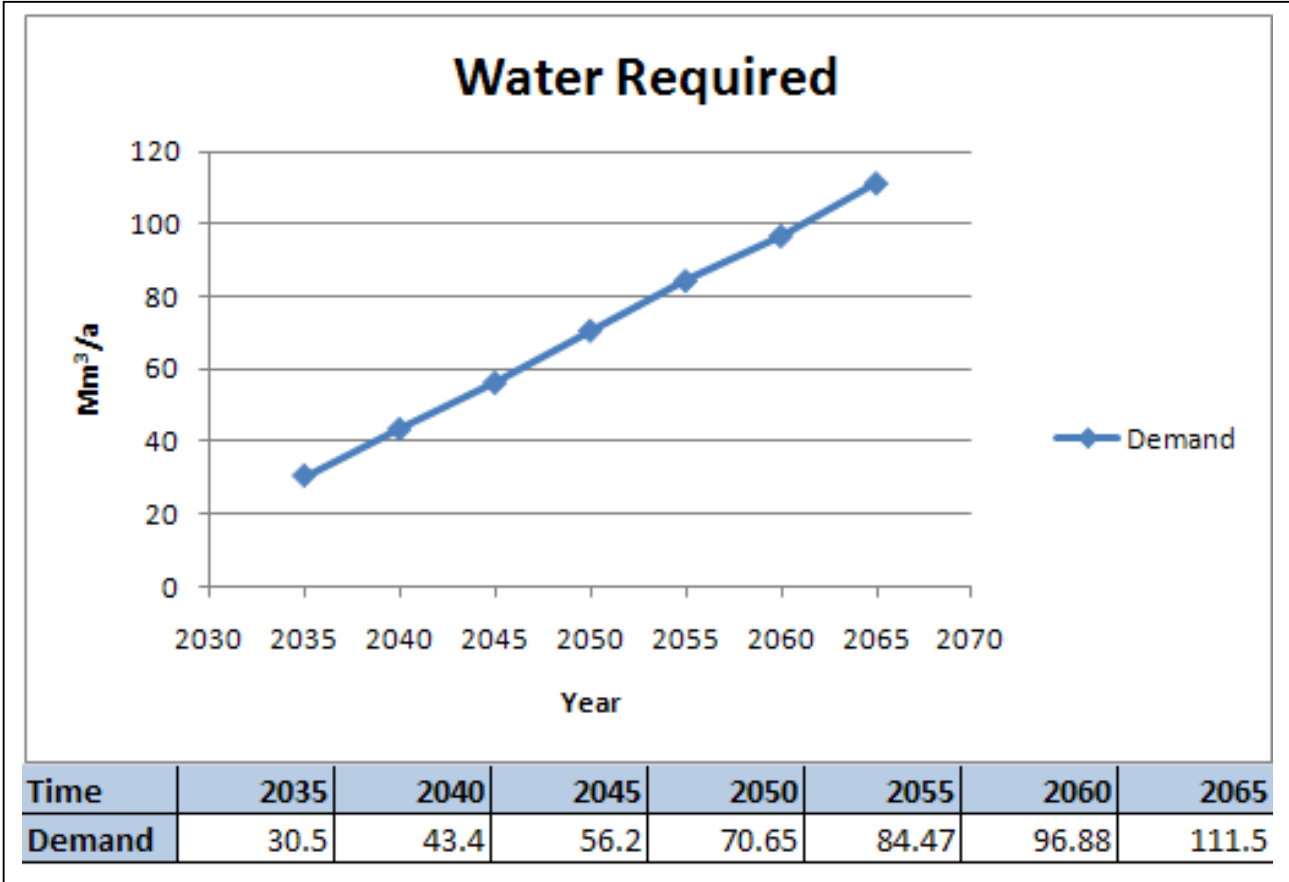

Figure 1-1: Water Demand Projection

2. PRE-FEASIBILITY OVERVIEW

This pre-feasibility study compares two routes of a large diameter pipeline from the proposed agro-industry development south of Pandamatenga and ending into a new Break Pressure Tank close to BPT 1. The results of the pre-feasibility study include the recommended route, preliminary system sizes (pipe diameters, various valve sizes, reservoirs and pump sizes), preliminary costing of the proposed pipeline system and a recommended control philosophy.

The proposed pipeline route from Pandamatenga reservoir to BPT1 is provided in **Figure 2-1**.

The proposed pipeline route follows the A1 highway up to Francistown. South of Francistown two alternative routes were identified. The first route continues along the A1 up to Serule, and then follows the road to Selebi Phikwe to the North-South carrier. The second alternative follows the A1 to the road bridge crossing the Shashe River, after which it turns left towards the same end-point along the North-South carrier. The two alternatives are shown in **Figure 2-2**. The advantage of the second alternative route is that it is shorter, the disadvantage being that it will not be possible to supply Serule from the pipeline.

Both proposed routes discharge into BPT 1, but the routes differ from chainage 420km. The two routes will be referred to as R1 and R2 throughout this report. R1 goes through Serule before joining BPT1 whereas R2 goes directly to BPT 1. R1 is 520km long and R2 is 500km long.

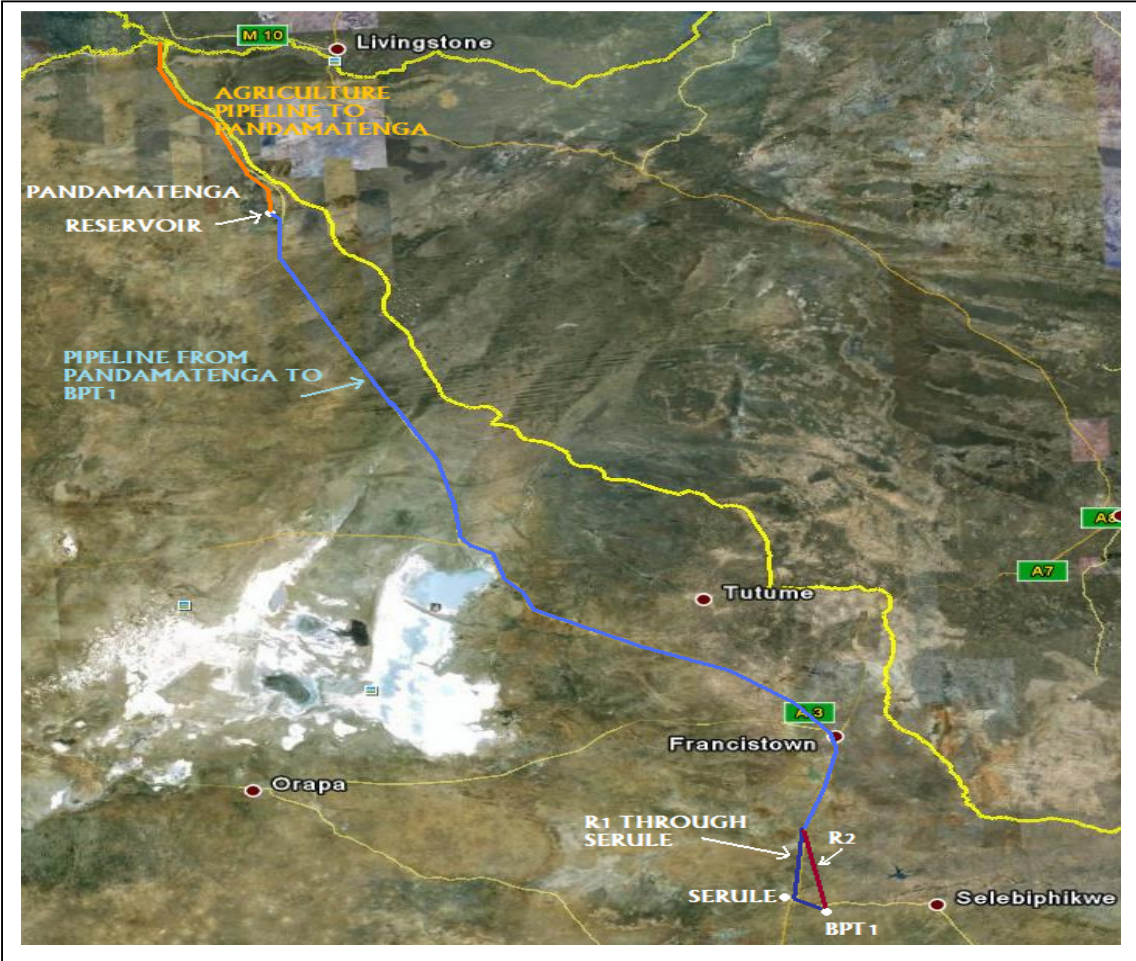

Figure 2-1: Pipeline Route

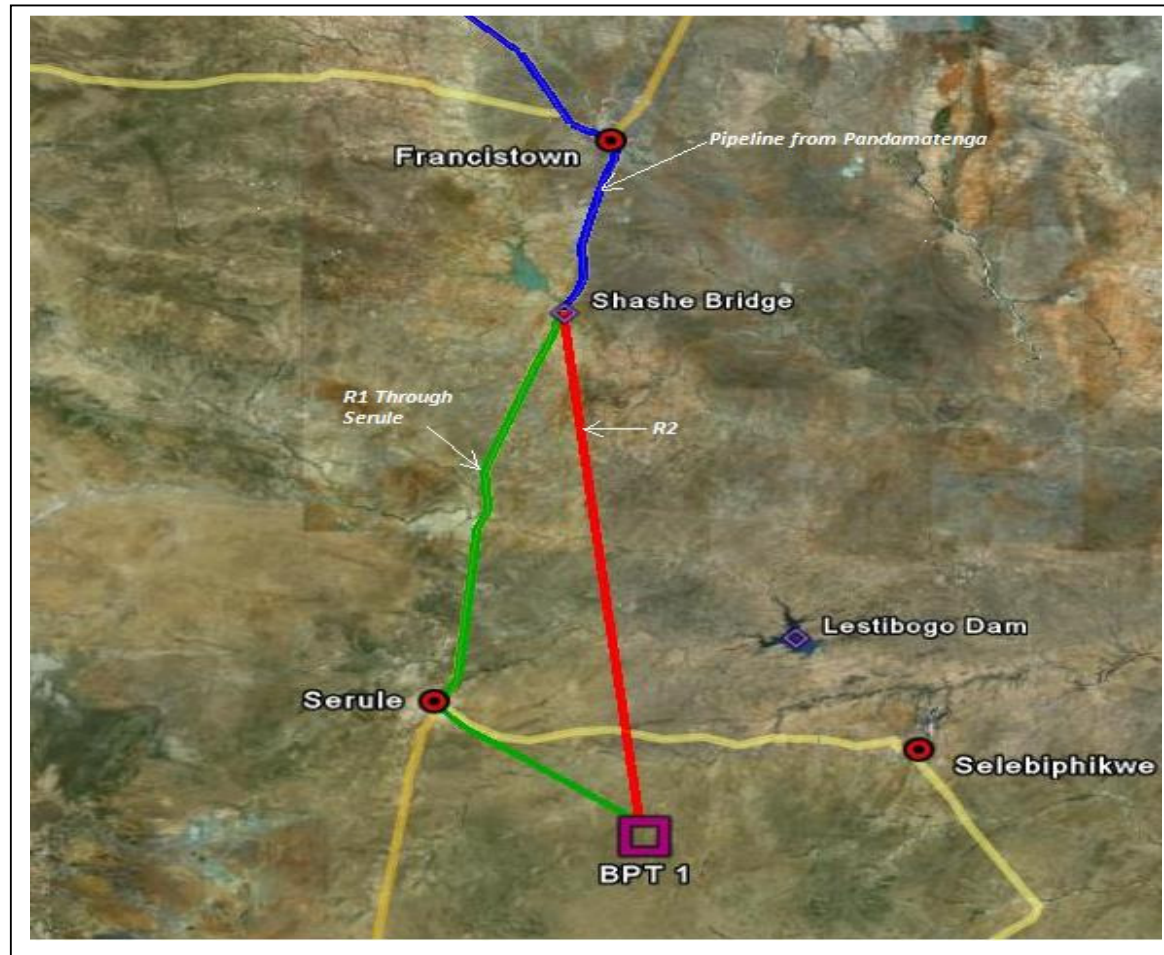

Figure 2-2: Alternative Route

2.1 METHODOLOGY

The information used are longitudinal profiles for the two routes and an estimated transfer rate of 100Mm³/a. The longitudinal profile's elevations are provided at intervals of 2kms. Control points were established along the route and are illustrated in **Figure 2-3**; a high point near the police station south of Pandamatenga, a low point at Nata and another high point near Francistown.

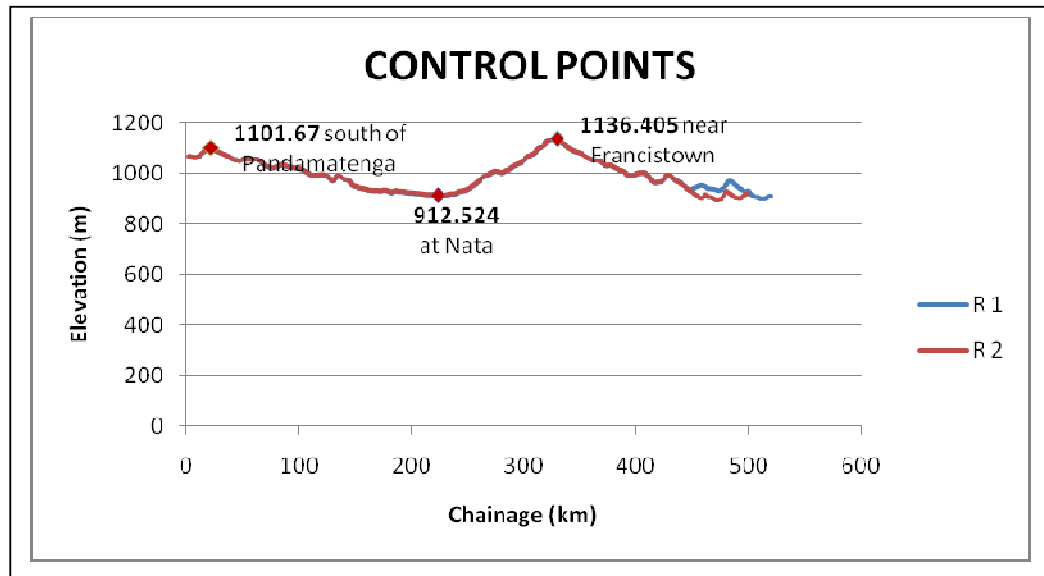

Figure 2-3: Control Points

Different options were compared not only pertaining to the two route alternatives, but to different operational philosophies as well. The two route alternatives were included in these options. Mechanical Flow Diagrams (MFDs) were generated to illustrate these different options and are provided in the chapter on Option Analyses. The operational philosophies of the option are described in the MFDs. The preliminary sizing of these options is directly related to the MFD of the appropriate option. The different options were compared utilising life-cycle costing and risk/benefit comparisons. The control philosophy of each option was not generated as it was not utilised in option comparison. The control philosophy of the selected option was produced and is provided in the latter parts of the report.

2.2 OPTION DESCRIPTION

Various options (operational philosophies) for transferring the water to BPT 1 were devised for both routes. All of these options were compared and are summarised in **Table 2-1**. Details of the options together with complete transfer scheme hydraulics and life cycle costing are provided in the chapter on Option Analysis.

Option 1 is to provide a single pump station at the start of the route, and to lift the water high enough to clear all the high points along the route. The advantage of this option is that there is only one operational point. Disadvantages are that the pressure in the pipeline at some points along the route becomes very high, and that for a pipeline of this length the operation with only one operational point presents some risks. Refer to **Figure 2-4**.

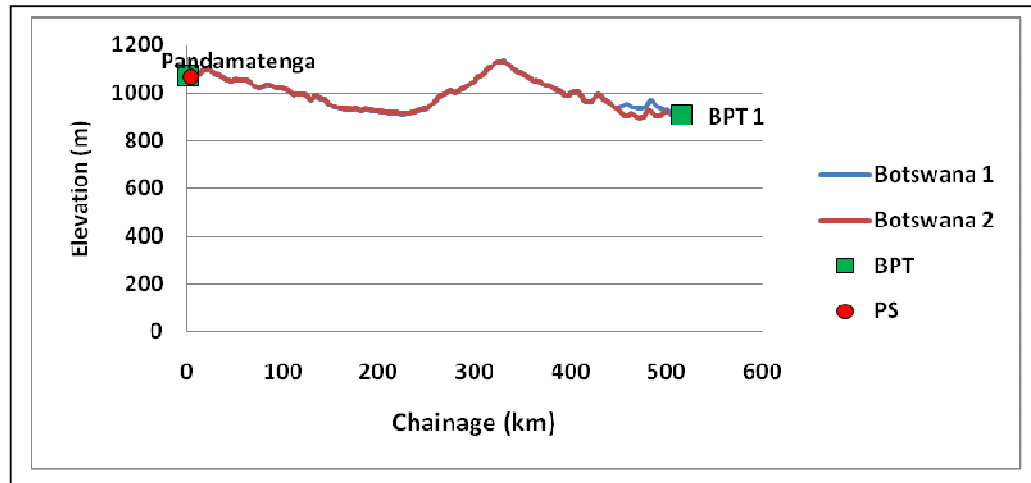

Figure 2-4: Option 1 Control Points

Option 2 is a slight variation on Option 1 in the sense that the initial pump line reaches to Francistown, after which the water gravitates to BPT1. This reduces the energy cost. This option has some operational advantages. Amongst others it will be easier to provide Francistown with water from the system. Refer to **Figure 2-5**.

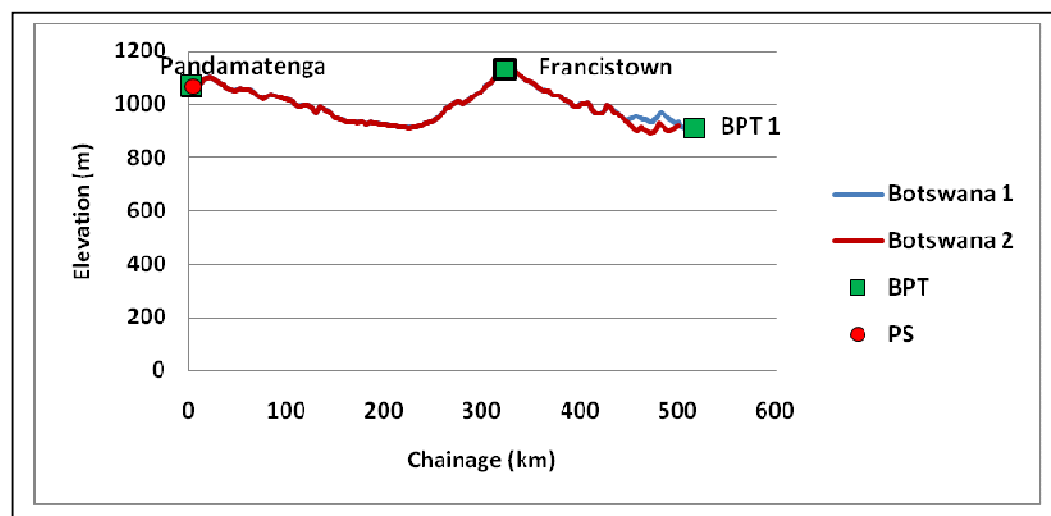

Figure 2-5: Option 2 Control Points

Option 3 consists of a relatively low lift pump to deliver the water to the first high point to the south of Pandamatenga, from where it gravitates to a point between Nata and Francistown. A high lift pump then lifts the water over the high point at Francistown and delivers it to BPT1. This option has the advantage that it maximises the use of gravity. Refer to **Figure 2-6**.

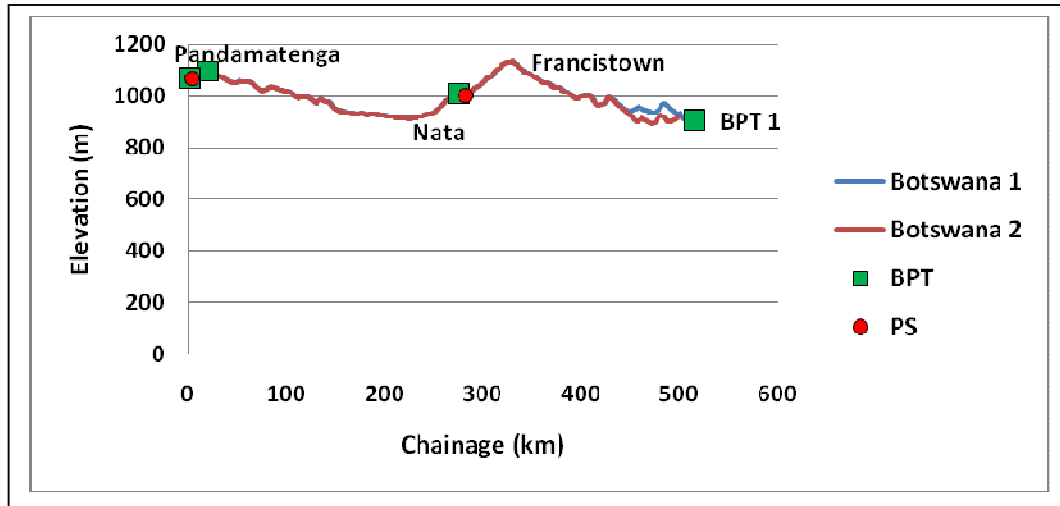

Figure 2-6: Option 3 Control Points

Option 4 is a variation on Option 3, but in this case the water gravitates to Nata from where it is pumped to BPT1. This option has the advantage that a substantial portion of the pipeline is subjected to low pressure, and that a future off-take to Maun can easily be provided. Refer to

Figure 2-7.

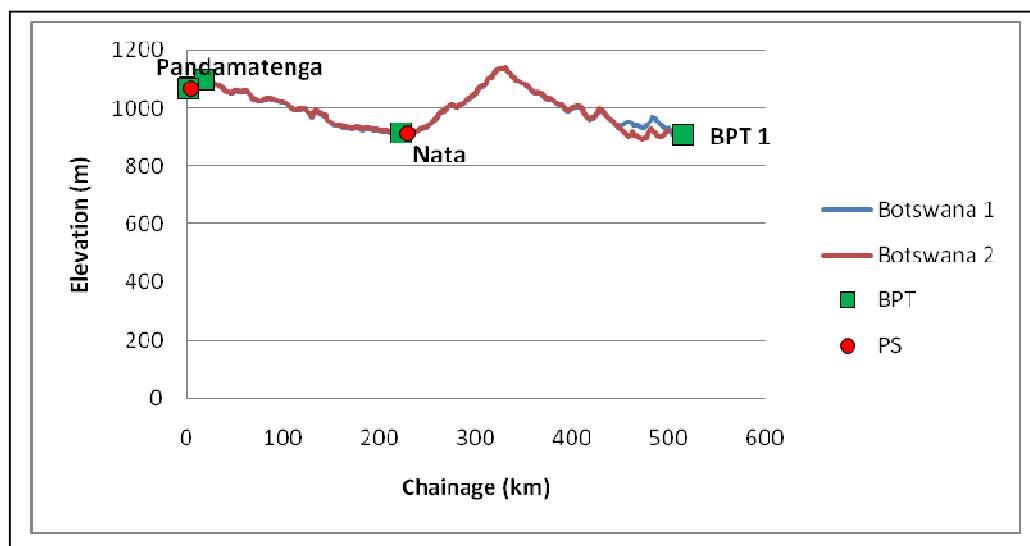

Figure 2-7: Option 4 Control Points

Option 5 is a further variation on Option 3. The water is lifted to the high point south of Pandamatenga, gravitates to Nata and is then lifted to Francistown. From here it is pumped to a break-pressure tank at Francistown and then gravitates to BPT1. Refer to **Figure 2-8**.

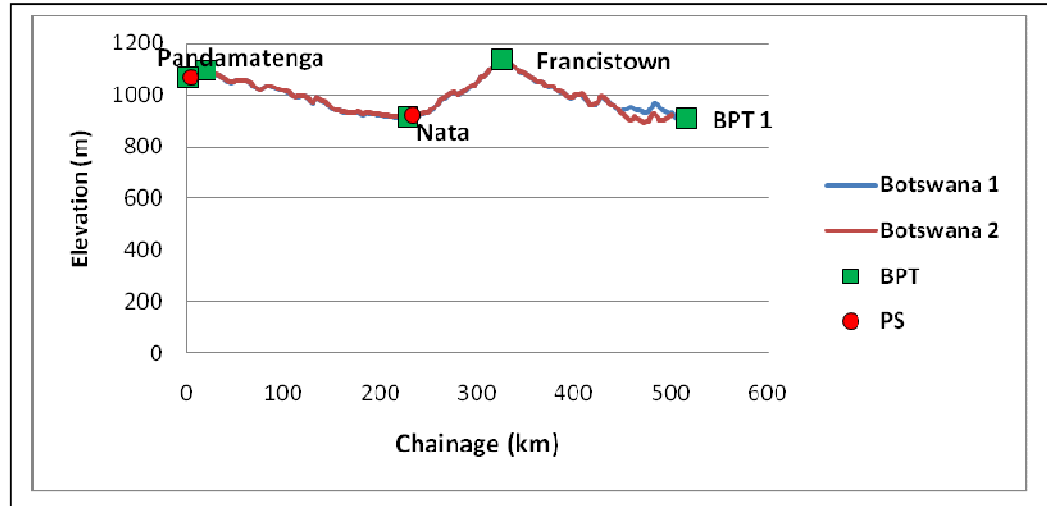

Figure 2-8: Option 5 Control Points

Option 6 sees the water being pumped to the high point south of Pandamatenga, from where it gravitates to Nata. From Nata it is pumped to an intermediate booster pump station, and then to Francistown. The rest of the pipeline is then a gravity section. This option results in the lowest pressures over the entire length of the pipeline. Refer to **Figure 2-9**.

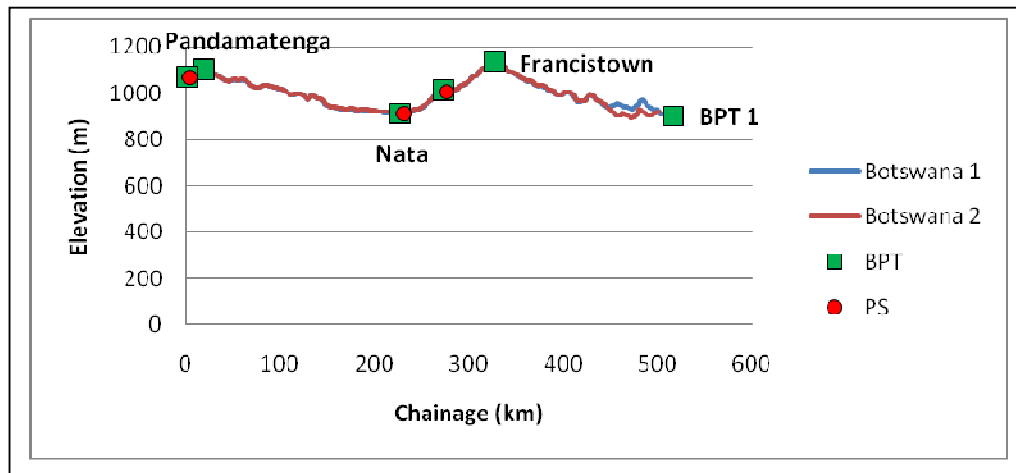

Figure 2-9: Option 6 Control Points

Options 2, 3, 4 and 6 have break pressure tanks. These reservoirs will give an advantage of supplying water when there is an interruption of flow from the transmission main and provide supplemental water during peak periods. The reservoirs will sectionalize the pipe to reduce mean pressures and transmission pressures. If an uninterrupted supply is desired, options with reservoirs must be considered because large fluctuations in demand can be tolerated in these systems. Options 1 and 5 do not have additional reservoirs; therefore these systems must be designed in such a way that there will be continuous adjustment of the flow within safe pressure limits. For the gravity pipelines, this will require pressure regulating valves.

Table 2-1: Pre-Feasibility Options

Option Name	Route	Pump Station Chainage (km)	Pump Station Name	Break Pressure Chainage	Break Pressure Name
Option 1A	R1	8	PS 1	No additional break pressure	NA
Option 1B	R2	8	PS 1	No additional break pressure	NA
Option 2A	R1	8	PS 1	330	BPT 2
Option 2B	R2	8	PS 1	330	BPT 2
Option 3A	R1	8 274	PS 1 PS 2	22 274	BPT 3 BPT 4
Option 3B	R2	8 274	PS 1 PS 2	22 274	BPT 3 BPT 4
Option 4A	R1	8 228	PS 1 PS 3	22 228	BPT 3 BPT 5
Option 4B	R2	8 228	PS 1 PS 3	22 228	BPT 3 BPT 5
Option 5A	R1	8	PS 1	No additional break pressure	NA
Option 5B	R2	8	PS 1	No additional break pressure	NA
Option 6A	R1	8 228 274	PS 1 PS 3 PS 2	22 228 274 330	BPT 3 BPT 5 BPT 4 BPT 2
Option 6B	R2	8 228 274	PS 1 PS 3 PS 2	22 228 274 330	BPT 3 BPT 5 BPT 4 BPT 2

3. DESIGN AND CALCULATION CRITERIA

The criteria to which the pipeline system was designed and priced (life cycle analysis) are provided as a reference as they play an integral role in the options comparison. The philosophy for converting the estimated transfer rate demand to a design flow rate is also noted. The criteria listed here were utilised throughout all calculations unless otherwise stated.

3.1 PIPELINE DESIGN CRITERIA

The pipeline is to be constructed from **Grade X42** steel with a yield stress of 300MPa. The maximum percentage yield of the steel that was used in the calculation of the pipe wall thickness was accepted as 50%. The minimum D/t (diameter/wall thickness) for the pipeline is 160. The calculation of the pipe wall thickness was calculated according to the guidelines provided in AWWA M11 and is described in greater detail in the latter parts of the report. The steel pipeline will have an epoxy lining. All friction losses in the pipeline are calculated using the Darcy-Weisbach formula. Allowance was made for an 8mm reduction in diameter to allow for the influence of biofilm and a k value of 0.5mm was utilised. Secondary losses were calculated utilising a kl factor of 175 over the entire pipeline.

The maximum velocity in the pipeline should not exceed 3.5m/s and should be determined from the design optimisation. The scour velocity in the pipeline should not exceed 0.5m/s and the velocity through the scour outlet should not exceed 6m/s. The filling velocity will be restricted by the maximum filling flow rate of 15% of the design flow rate. A minimum residual head of 10m is to be maintained within the pipeline.

The pipeline diameters were selected according the above criteria; they were chosen as such to ensure there is sufficient head within the system, but with the smallest possible diameter. The same pipeline diameter sizing procedure was utilised for all the options. The heads and diameters were evaluated and chosen on a consistent philosophy in order to obtain an operational consistent scheme to utilise in the life cost cycle analysis.

3.2 PUMP STATION DESIGN CRITERIA

Duty and standby pump sets are to be provided such that pumping can continue even if a pump set is out of order. All of the pumps can be operated simultaneously as well in emergencies. The pumping times are not limited to a certain value, but will be determined in the design optimisation. The upstream reservoir minimum operating level is accepted to be 10m higher than the NGL level. All other reservoirs are to have top inlets and heights of 10m. The reservoir sizes were calculated in order to have a minimum of 24 hours storage. Pumps are not specified but the power required by the pumps was calculated in order to calculate electricity costs with the

equation below. It is noted that there are no peak tariffs for electricity in Botswana and therefore the pumps will be utilised at any time of the day.

$$Power = \rho gQH/\xi$$

Where;

ρ = Density of water in Kg/m³

g = Acceleration due to gravity in m/s²

Q = Discharge in m³/s

H = Head of water in m

ξ = Motor Efficiency

3.3 OPERATION PHILOSOPHY

The supply system will have the capacity to supply the required 100 Mm³/a. Local storage of 18 days will be provided at the end reservoir and thus allowing 18 days maintenance on the pipeline system per year. All of the operational reservoirs and break pressure tanks are to have storage of at least 24 hours.

The peak demand flow (PDF) was calculated by multiplying the average annual daily demand (AADD) with various peak factors. The scheme capacity design flow will be adjusted to allow the full annual requirements to be supplied in 347 days (365 - 18 days storage). To cater for this, a peak factor (P_f) of 1.052 will be utilised in the peak design flow calculation (PDF) ($P_f = 365/347 = 1.052$). An allowance of 2% in system losses is to be made; $P_l = 1.02$. An allowance for recovering the 18 days storage volume is to be made. The storage should be replenished in 90 days, ($P_R = (18+90)/90 = 1.2$). The AADD was calculated using the equation:

$$AADD = \frac{AD}{365} m^3/day$$

$$AADD = \frac{AD}{(365 \times 24)} m^3/hour$$

$$AADD = \frac{AD}{(365 \times 24 \times 60 \times 60)} m^3/second$$

The PDF was therefore calculated as follows:

$$PDF = AADD \times P_f \times P_l \times P_R$$

The calculated peak design flow that was utilised throughout this report equals to 1.29XAADD or **4.083m³/s**. For the life cycle analysis of the options, a pumping time of 24 hours was utilised and therefore no additional factor is required. For this competitive analysis no allowance was made for flow reduction due to water supply

along the pipeline route. This will in reality be relatively small and not affect the outcome.

3.4 LIFE CYCLE COSTING CRITERIA

The social discount rate, according to the Government of Botswana Central Statistics Office, is 8%. To test the sensitivity of the Net Present Value to the discount rates, a discount rate of +2% and -2% was also used. The year 2010 was utilised as the base year for the Life Cycle Cost Analysis (LCCA) and the project lifetime was assumed as 60 years and the construction period of the scheme was assumed as 4 years. All cost related calculations were determined using the exchange rate of Botswana Pula (BWP) 1.00 = South African Rand (ZAR) 1.10. Energy tariffs utilised in the life cycle costing were obtained from Botswana Power Corporation as provided in **Appendix A** and the energy cost for pump stations is provided in **Table 3-1**

Table 3-1: Botswana Pump Station Energy Tariffs

Electricity Costs	Pula
Fixed Charge Per Month	26.09
Energy Charge Per kWh	0.4096

Only costs referring to the construction and maintenance of the transfer scheme were utilised in the LCCA. All incomes relating to the project were not included in the LCCA for this study as it is a Pre-Feasibility study focused on the choice of two route options and not project viability and Internal Rate of Return (IRR) of the project. It was assumed that the professional fees for the project will be constant for the project and therefore these were not included in the LCCA. The following equation was utilised to calculate the Net Present Value (NPV) for the expenditure of each year to 2010 monetary value.

$$P = \frac{F}{(1+i)^n}$$

Where: *P* = Present Value

F = Future Value

n = Number of years

i = Discount Rate

Cost estimates were obtained for all the transfer scheme components. These estimates were all escalated to 2010 prices. These cost estimates for the various components are provided in **Appendix B**. These prices were assumed to be accurate and were utilised throughout the option analyses.

A simplified approach for calculating the pipe trench excavation and back filling volumes was utilised. The following dimensions for the pipe trench were utilised:

- Side Allowance = 500mm
- Bedding Height = 200mm
- Cradle Selected Fill Height = 300mm
- Minimum Cover = 1800mm (i.e. Main Backfill Height = 1500mm)

4. OPTION ANALYSES

4.1 GENERAL

The longitudinal profiles for R1 and R2 are provided in **Figure 4-1**. All calculations were performed as described in the methodology. The summaries and important values for each option are provided under the applicable option together with a short description of the option and the applicable MFD. The calculations for the option analyses are not provided in this due to the amount of data and number of pages. All of these calculations are supplied in electronic format on the supporting CD provided.

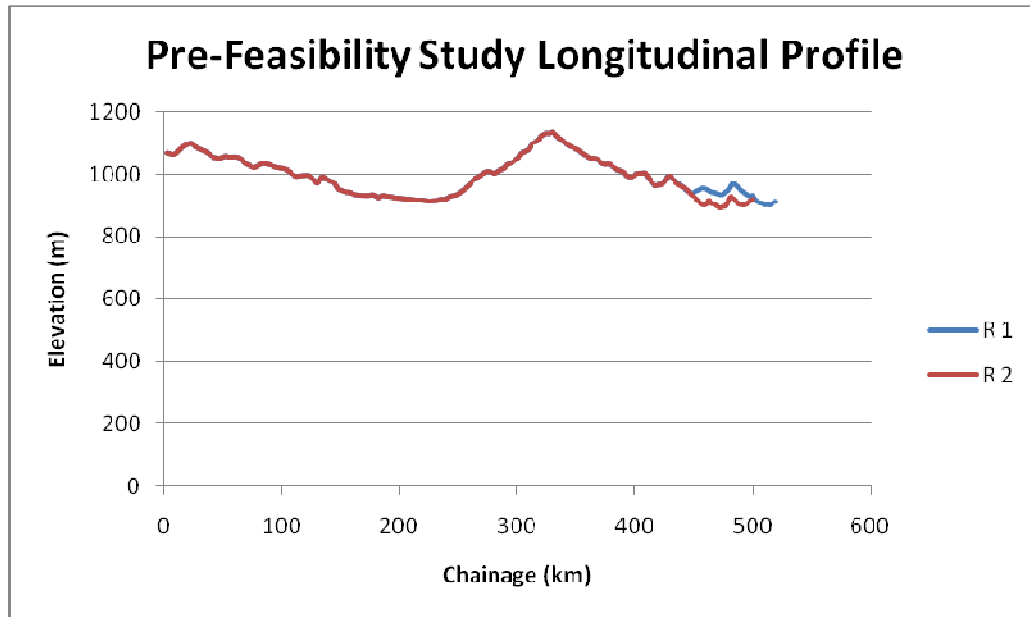

Figure 4-1: Pre-Feasibility Study Longitudinal Profile

4.2 OPTION 1A

Option 1A consists of a single pump station and no break pressure reservoir on the line. The pump station PS1 is positioned at chainage 8 km at an elevation of 1063.832m. The pipeline follows R1. The MFD illustrating the transfer scheme is provided in **Figure 4-2**. The pipeline thickness is varied. The longitudinal profile of the pipeline together with the position of the pump station and end reservoir is illustrated in **Figure 4-3**. The hydraulic grade-line for the option is also illustrated in this figure. The hydraulic system components as sized according to the procedure, described in Methodology, are summarised in **Table 4-1**. The hydraulic calculations are provided electronically in Option 1A.excel sheets on the supporting CD.

Option 1A Summary			
Item	Chainage (km)	Value	
Pipeline	0-8	2.2	m - Diameter
Pump Station	8	200	m - Pumping head
Pipeline	8-322	2.2	m - Diameter
Pipeline	322-356	2.0	m - Diameter
Pipeline	356-504	1.8	m - Diameter
Pipeline	504-520	1.5	m - Diameter

Table 4-1: Option 1A Hydraulic Components

The capital costs as calculated for the LCCA for Option 1A are provided in **Table 4-2** and the calculated maintenance costs are provided in **Table 4-3**. The electricity costs for the option are summarised in **Table 4-4**. The complete life cycle costing calculation is provided in **Table 4-5**. The Net Present Value (NPV) for the option was calculated for the three different discount rates analysed by taking the yearly expenditure back to a 2010 present value. The calculated NPVs are compared in greater detail in Option Comparison. Option 1A's LCCA calculations are provided electronically in Option 1A LCCA excel sheets.

Table 4-2: Option 1A Capital Costs

Option 1A Capital Costs (PULA)	
Pipe Cost	7,130,000,000.00
Pipe Laying and Joining	1,430,000,000.00
Pipe Trench Excavation & Back Fill	829,000,000.00
Air Valve, Scour Valve & Isolating Cost	365,000,000.00
Pump Station Cost PS 1	76,230,000.00
Total	9,830,230,000.00

Table 4-3: Option 1A Annual Maintenance Costs

Option 1A Maintenance Costs (Pula)		
Item	Percentage Per Annum	Cost P/year
Civil	0.50%	36,000,000.00
Mechanical & Electrical	4%	18,000,000.00
Total		54,000,000.00

Table 4-4: Option 1A Energy Costs Summary

Pipe Type	Energy Cost Per Year (PULA)
New Pipe	25,200,000.00
Average Pipe	26,500,000.00
Old Pipe	29,000,000.00
Biofilm Pipe	32,000,000.00

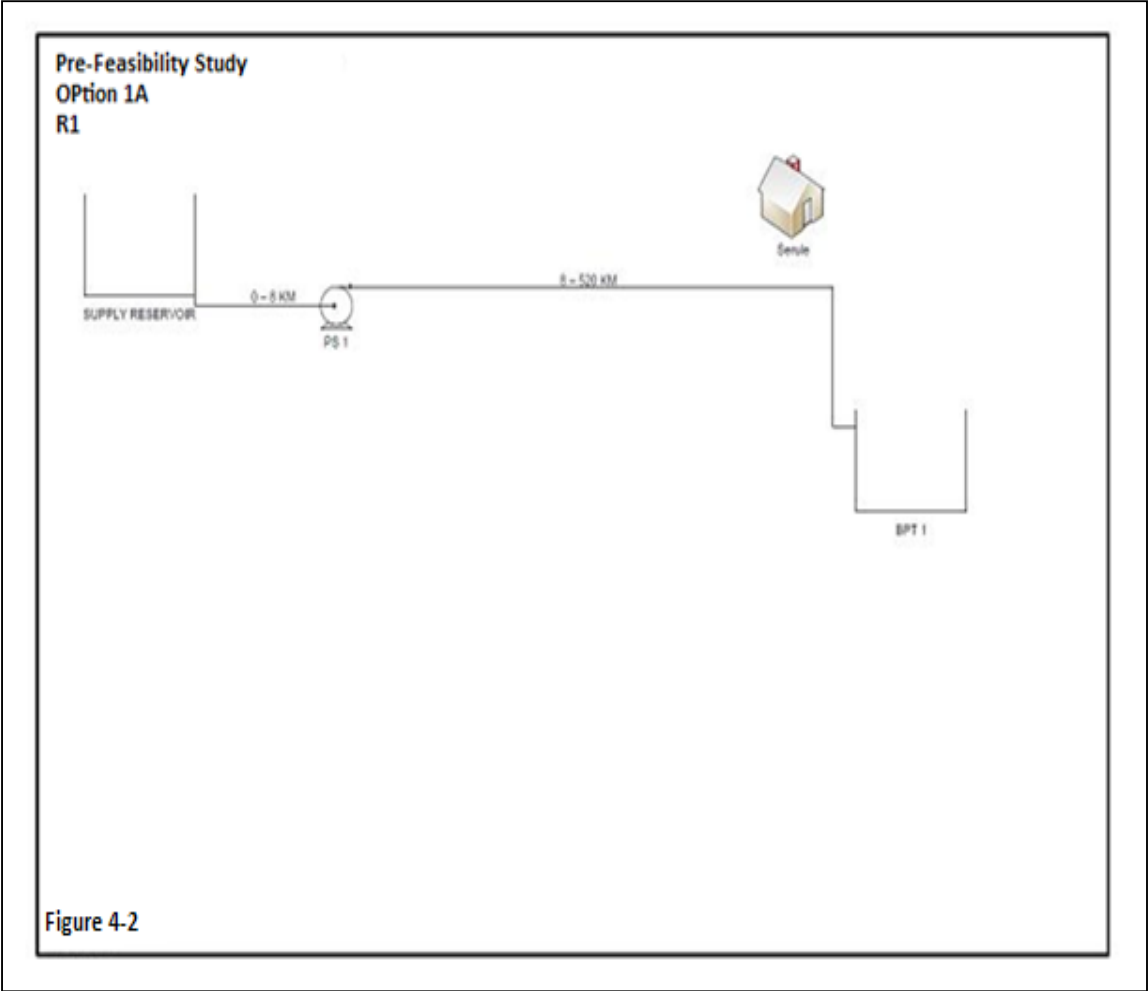

Figure 4-2: Option 1A MFD

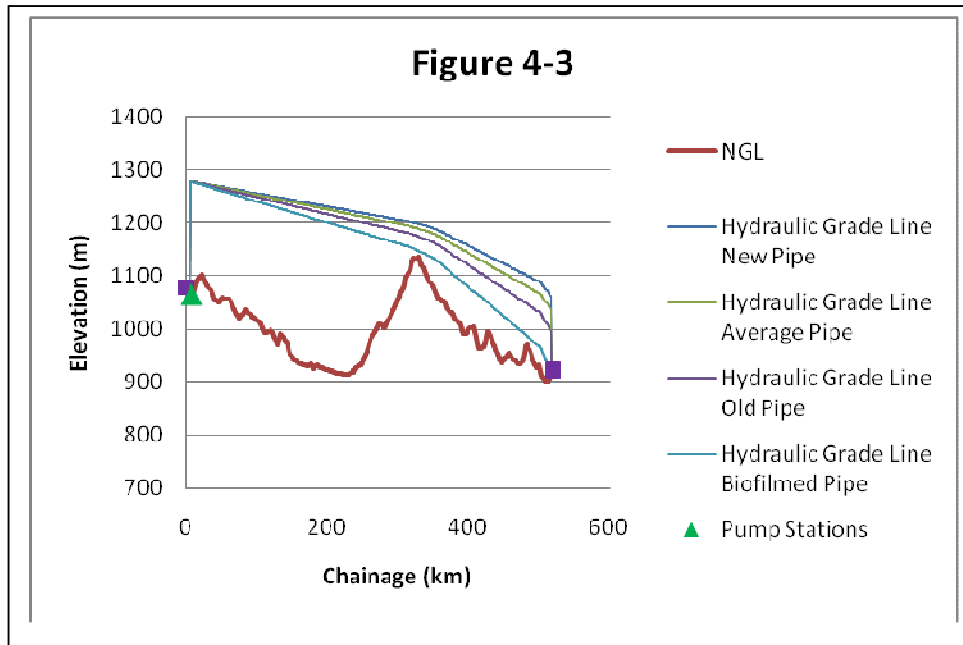

Figure 4-3: Option 1A Longitudinal and Energy Profile

Table 4-5: Option 1A Life Cycle Costing

Table 4-5: Option 1A Life Cycle Costing (Pula)							
Reference Year	Water Demand (Mm ³)	Capital Cost	Electricity - Pumping Cost	Maintenance Cost	NPV at 6% Discount Rate	NPV at 8% Discount Rate	NPV at 10% Discount Rate
0	69.80	2,456,200,000			2,456,200,000	2,456,200,000	2,456,200,000
1	70.66	2,456,200,000			2,456,200,000	2,456,200,000	2,456,200,000
2	71.57	2,456,200,000			2,456,200,000	2,456,200,000	2,456,200,000
3	73.23	2,456,200,000			2,456,200,000	2,456,200,000	2,456,200,000
4	74.19	-	25,163,000	53,269,000	62,125,000	57,650,000	53,570,000
5	74.64	-	25,163,000	53,269,000	58,609,000	53,379,000	48,700,000
6	75.58	-	25,163,000	53,269,000	55,291,000	49,425,000	44,273,000
7	76.56	-	25,163,000	53,269,000	52,162,000	45,764,000	40,248,000
8	77.56	-	25,163,000	53,269,000	49,209,000	42,374,000	36,589,000
9	78.56	-	25,163,000	53,269,000	46,424,000	39,236,000	33,263,000
10	79.58	-	25,163,000	53,269,000	43,796,000	36,329,000	30,239,000
11	80.57	-	25,163,000	53,269,000	41,317,000	33,638,000	27,490,000
12	81.62	-	25,163,000	53,269,000	38,978,000	31,147,000	24,991,000
13	82.68	-	25,163,000	53,269,000	36,772,000	28,839,000	22,719,000
14	83.76	-	25,163,000	53,269,000	34,691,000	26,703,000	20,654,000
15	84.84	-	25,163,000	53,269,000	32,727,000	24,725,000	18,776,000
16	85.93	-	25,163,000	53,269,000	30,875,000	22,894,000	17,069,000

Table 4-5: Option 1A Life Cycle Costing (Pula)							
Reference Year	Water Demand (Mm ³)	Capital Cost	Electricity - Pumping Cost	Maintenance Cost	NPV at 6% Discount Rate	NPV at 8% Discount Rate	NPV at 10% Discount Rate
17	87.07	-	25,163,000	53,269,000	29,127,000	21,198,000	15,518,000
18	88.16	-	25,163,000	53,269,000	27,478,000	19,628,000	14,107,000
19	89.31	-	26,495,000	53,269,000	26,363,000	18,482,000	13,042,000
20	90.43	-	26,495,000	53,269,000	24,871,000	17,113,000	11,857,000
21	91.54	-	26,495,000	53,269,000	23,463,000	15,846,000	10,779,000
22	92.66	-	26,495,000	53,269,000	22,135,000	14,672,000	9,798,500
23	93.05	-	26,495,000	53,269,000	20,882,000	13,585,000	8,907,800
24	94.20	-	26,495,000	53,269,000	19,700,000	12,579,000	8,098,000
25	104.50	-	26,495,000	53,269,000	18,585,000	11,647,000	7,361,800
26	105.77	-	26,495,000	53,269,000	17,533,000	10,785,000	6,692,600
27	107.05	-	26,495,000	53,269,000	16,541,000	9,985,300	6,084,100
28	108.35	-	26,495,000	53,269,000	15,604,000	9,245,600	5,531,000
29	109.67	-	26,495,000	53,269,000	14,721,000	8,560,800	5,028,200
30	113.75	-	26,495,000	53,269,000	13,888,000	7,926,600	4,571,100
31	115.13	-	26,495,000	53,269,000	13,102,000	7,339,500	4,155,600
32	116.53	-	26,495,000	53,269,000	12,360,000	6,795,800	3,777,800
33	117.95	-	26,495,000	53,269,000	11,661,000	6,292,400	3,434,400
34	119.38	-	28,758,000	53,269,000	11,313,000	5,991,600	3,210,700
35	122.97	-	28,758,000	53,269,000	10,672,000	5,547,800	2,918,900
36	124.47	-	28,758,000	53,269,000	10,068,000	5,136,900	2,653,500
37	125.98	-	28,758,000	53,269,000	9,498,100	4,756,400	2,412,300
38	127.51	-	28,758,000	53,269,000	8,960,400	4,404,100	2,193,000
39	129.07	-	28,758,000	53,269,000	8,453,300	4,077,800	1,993,600
40	132.24	-	28,758,000	53,269,000	7,974,800	3,775,800	1,812,400
41	133.85	-	28,758,000	53,269,000	7,523,400	3,496,100	1,647,600
42	135.48	-	28,758,000	53,269,000	7,097,500	3,237,100	1,497,900
43	137.13	-	28,758,000	53,269,000	6,695,800	2,997,300	1,361,700
44	141.48	-	28,758,000	53,269,000	6,316,800	2,775,300	1,237,900
45	143.20	-	28,758,000	53,269,000	5,959,200	2,569,700	1,125,400
46	144.95	-	28,758,000	53,269,000	5,621,900	2,379,400	1,023,100
47	146.71	-	28,758,000	53,269,000	5,303,700	2,203,100	930,030
48	148.50	-	28,758,000	53,269,000	5,003,500	2,040,000	845,480
49	150.72	-	31,953,000	53,269,000	4,904,100	1,962,400	798,560
50	152.56	-	31,953,000	53,269,000	4,626,600	1,817,100	725,960
51	154.42	-	31,953,000	53,269,000	4,364,700	1,682,500	659,970
52	156.30	-	31,953,000	53,269,000	4,117,600	1,557,800	599,970
53	158.21	-	31,953,000	53,269,000	3,884,600	1,442,500	545,430
54	159.97	-	31,953,000	53,269,000	3,664,700	1,335,600	495,840
55	161.94	-	31,953,000	53,269,000	3,457,200	1,236,700	450,770
56	163.93	-	31,953,000	53,269,000	3,261,600	1,145,100	409,790
57	165.94	-	31,953,000	53,269,000	3,076,900	1,060,300	372,540

Reference Year	Water Demand (Mm ³)	Capital Cost	Electricity - Pumping Cost	Maintenance Cost	NPV at 6% Discount Rate	NPV at 8% Discount Rate	NPV at 10% Discount Rate
58	167.98	-	31,953,000	53,269,000	2,902,800	981,680	338,670
59	170.05	-	31,953,000	53,269,000	2,738,500	908,970	307,880
60	172.14	-	31,953,000	53,269,000	2,583,500	841,640	279,890
61	174.26	-	31,953,000	53,269,000	2,437,200	779,290	254,450
62	176.40	-	31,953,000	53,269,000	2,299,300	721,570	231,320
63	178.57	-	31,953,000	53,269,000	2,169,100	668,120	210,290
					10,903,000,000	10,602,000,000	10,416,000,000

4.3 OPTION 1B

Option 1B consists of a single pump station and no break pressure reservoir on the line. The pump station PS1 is positioned at chainage 8 km at an elevation of 1063.832m. The pipeline follows R2. The MFD illustrating the transfer scheme is provided in **Figure 4-4**. The longitudinal profile of the pipeline together with the position of the pump station and end reservoir is illustrated in **Figure 4-5**. The hydraulic grade-line for the option is also illustrated in this figure. The hydraulic system components as sized according to the procedure described in Methodology are summarised in **Figure 4-6**. The hydraulic calculations are provided electronically in Option 1B.excel sheets on the supporting CD.

Table 4-6: Option 1B Hydraulic Components

Item	Chainage (km)	Value	
Pipeline	0-8	2.2	m - Diameter
Pump Station	8	200	m - Pumping Head
Pipeline	8-330	2.2	m - Diameter
Pipeline	330-482	1.8	m - Diameter
Pipeline	482-500	1.5	m - Diameter

The capital costs as calculated for the LCCA for Option 1B are provided in **Table 4-7** and the calculated maintenance costs are provided in **Table 4-8**. The electricity costs for the option are summarised in **Table 4-9**. The complete life cycle costing calculation is provided in **Table 4-10**. The Net Present Value (NPV) for the option was calculated for the three different discount rates analysed by taking the yearly expenditure back to a 2010 present value. The calculated NPVs are compared in greater detail in Option Comparison. Option 1B's LCCA calculations are provided electronically in Option 1B LCCA excel sheets.

Table 4-7: Option 1B Capital Costs

Option 1B Capital Costs (Pula)	
Pipe Cost	6,910,000,000.00
Pipe Laying and Joining	1,400,000,000.00
Pipe Trench Excavation & Back Fill	800,000,000.00
Air Valve, Scour Valve & Isolating Cost	351,000,000.00
Pump Station Cost PS 1	77,000,000.00

Table 4-8: Option 1B Annual Maintenance Costs

Option 1B Maintenance Costs (Pula)		
Item	Percentage Per Annum	Cost P/year
Civil	0.50%	35,000,000.00
Mechanical & Electrical	4%	17,100,000.00
Total		52,000,000.00

Table 4-9: Option 1B Energy Costs Summary

Pipe Type	Energy Cost Per Year (Pula)
New Pipe	25,200,000.00
Average Pipe	27,000,000.00
Old Pipe	29,000,000.00
Biofilm Pipe	32,000,000.00

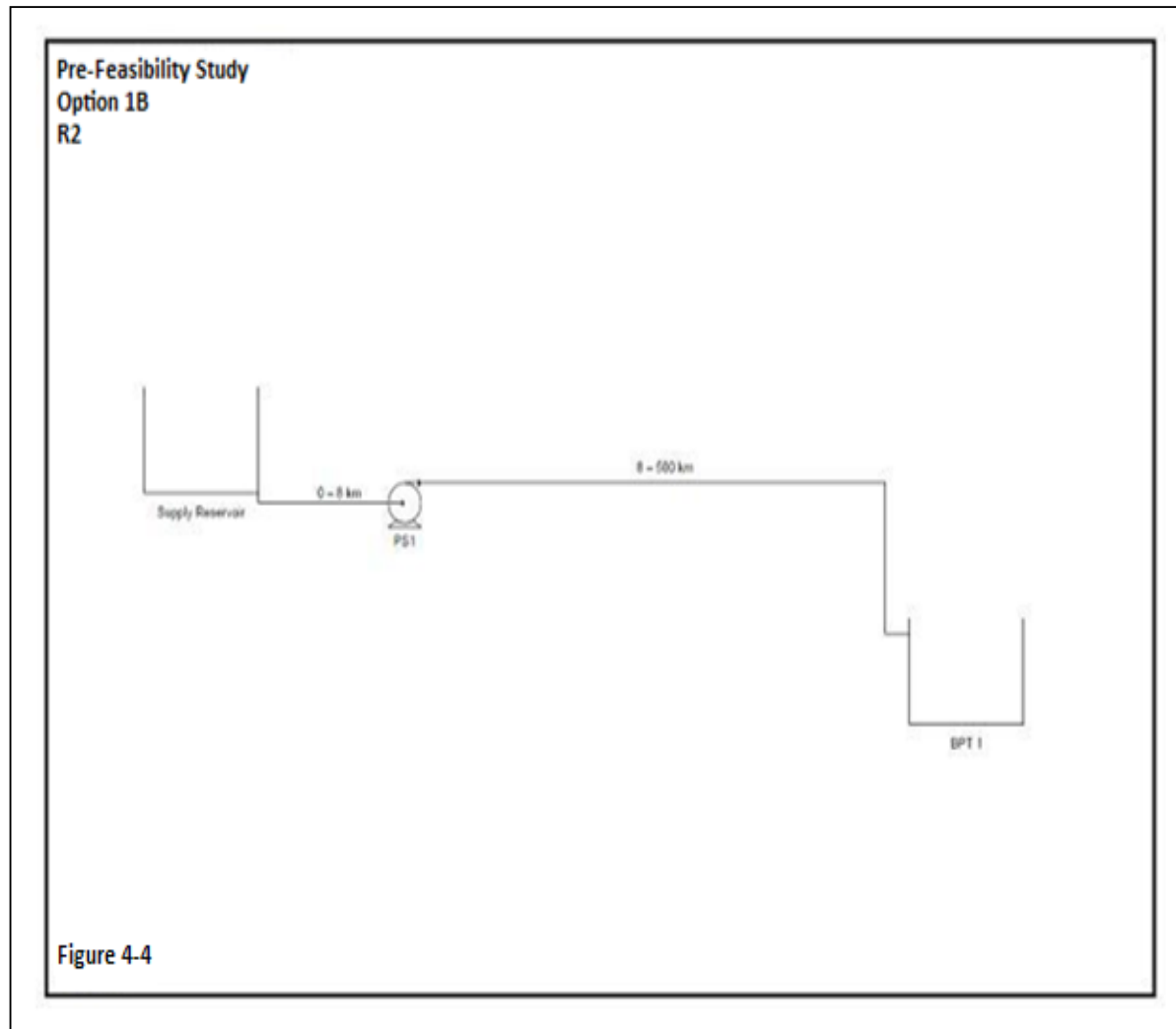

Figure 4-4 Option 1B MFD

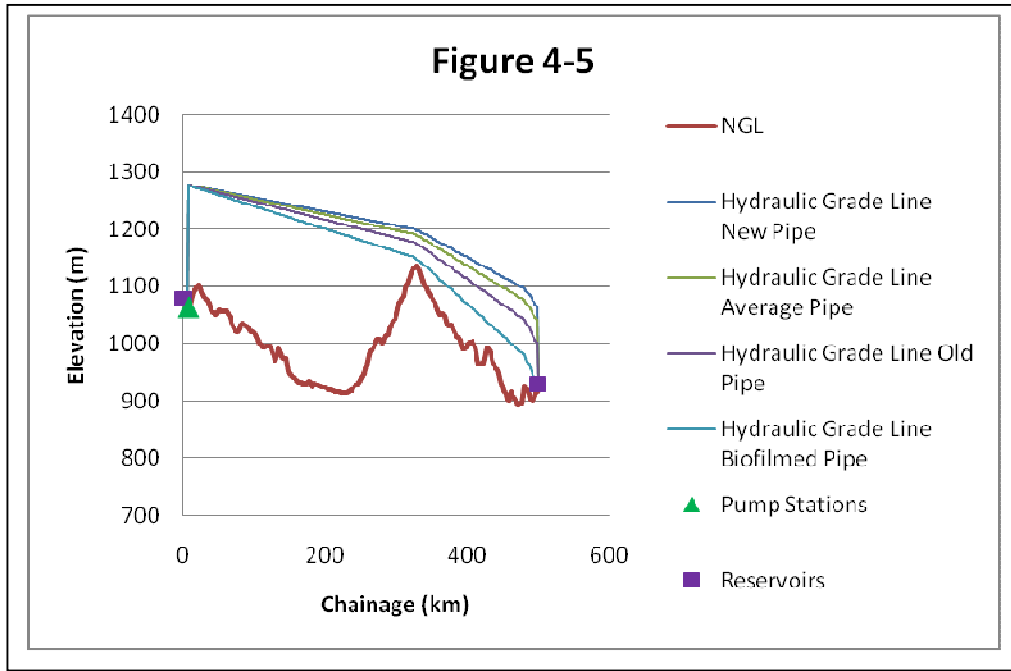

Figure 4-5: Option 1B Longitudinal and Energy Profile

Table 4-10: Option 1B Life Cycle Costing

Table 4-10: Option 1B Life Cycle Costing (Pula)							
Reference Year	Water Demand (Mm ³)	Capital Cost	Electricity - Pumping Cost	Maintenance Cost	NPV at 6% Discount Rate	NPV at 8% Discount Rate	NPV at 10% Discount Rate
0	69.80	2,379,000,000			2,379,000,000	2,379,000,000	2,379,000,000
1	70.66	2,379,000,000			2,379,000,000	2,379,000,000	2,379,000,000
2	71.57	2,379,000,000			2,379,000,000	2,379,000,000	2,379,000,000
3	73.23	2,379,000,000			2,379,000,000	2,379,000,000	2,379,000,000
4	74.19	-	25,163,000	51,624,000	60,822,000	56,441,000	52,446,000
5	74.64	-	25,163,000	51,624,000	57,380,000	52,260,000	47,679,000
6	75.58	-	25,163,000	51,624,000	54,132,000	48,389,000	43,344,000
7	76.56	-	25,163,000	51,624,000	51,068,000	44,804,000	39,404,000
8	77.56	-	25,163,000	51,624,000	48,177,000	41,486,000	35,822,000
9	78.56	-	25,163,000	51,624,000	45,450,000	38,413,000	2,565,000
10	79.58	-	25,163,000	51,624,000	42,877,000	35,567,000	29,605,000
11	80.57	-	25,163,000	51,624,000	40,450,000	32,933,000	26,913,000
12	81.62	-	25,163,000	51,624,000	38,161,000	30,493,000	24,467,000
13	82.68	-	25,163,000	51,624,000	36,001,000	28,234,000	22,242,000
14	83.76	-	25,163,000	51,624,000	33,963,000	26,143,000	20,220,000
15	84.84	-	25,163,000	51,624,000	32,040,000	24,206,000	18,382,000

Table 4-10: Option 1B Life Cycle Costing (Pula)							
Reference Year	Water Demand (Mm ³)	Capital Cost	Electricity - Pumping Cost	Maintenance Cost	NPV at 6% Discount Rate	NPV at 8% Discount Rate	NPV at 10% Discount Rate
16	85.93	-	25,163,000	51,624,000	30,227,000	22,413,000	16,711,000
17	87.07	-	25,163,000	51,624,000	28,516,000	20,753,000	15,192,000
18	88.16	-	25,163,000	51,624,000	26,902,000	19,216,000	13,811,000
19	89.31	-	26,627,000	51,624,000	25,863,000	18,132,000	12,795,000
20	90.43	-	26,627,000	51,624,000	24,399,000	16,789,000	11,632,000
21	91.54	-	26,627,000	51,624,000	23,018,000	15,545,000	10,574,000
22	92.66	-	26,627,000	51,624,000	21,715,000	14,394,000	9,612,900
23	93.05	-	26,627,000	51,624,000	20,486,000	13,327,000	8,739,000
24	94.20	-	26,627,000	51,624,000	19,326,000	12,340,000	7,944,500
25	104.50	-	26,627,000	51,624,000	18,232,000	11,426,000	7,222,300
26	105.77	-	26,627,000	51,624,000	17,200,000	10,580,000	6,565,700
27	107.05	-	26,627,000	51,624,000	16,227,000	9,796,000	5,968,800
28	108.35	-	26,627,000	51,624,000	15,308,000	9,070,400	5,426,200
29	109.67	-	26,627,000	51,624,000	14,442,000	8,398,500	4,932,900
30	113.75	-	26,627,000	51,624,000	13,624,000	7,776,400	4,484,500
31	115.13	-	26,627,000	51,624,000	12,853,000	7,200,400	4,076,800
32	116.53	-	26,627,000	51,624,000	12,126,000	6,667,000	3,706,200
33	117.95	-	26,627,000	51,624,000	11,439,000	6,173,200	3,369,200
34	119.38	-	28,757,000	51,624,000	11,086,000	5,871,500	3,146,300
35	122.97	-	28,757,000	51,624,000	10,458,000	5,436,600	2,860,300
36	124.47	-	28,757,000	51,624,000	9,866,100	5,033,900	2,600,300
37	125.98	-	28,757,000	51,624,000	9,307,600	4,661,000	2,363,900
38	127.51	-	28,757,000	51,624,000	8,780,800	4,315,700	2,149,000
39	129.07	-	28,757,000	51,624,000	8,283,700	3,996,000	1,953,600
40	132.24	-	28,757,000	51,624,000	7,814,900	3,700,000	1,776,000
41	133.85	-	28,757,000	51,624,000	7,372,500	3,426,000	1,614,600
42	135.48	-	28,757,000	51,624,000	6,955,200	3,172,200	1,467,800
43	137.13	-	28,757,000	51,624,000	6,561,500	2,937,200	1,334,400
44	141.48	-	28,757,000	51,624,000	6,190,100	2,719,600	1,213,000
45	143.20	-	28,757,000	51,624,000	5,839,700	2,518,200	1,102,800
46	144.95	-	28,757,000	51,624,000	5,509,200	2,331,600	1,002,500
47	146.71	-	28,757,000	51,624,000	5,197,300	2,158,900	911,380
48	148.50	-	28,757,000	51,624,000	4,903,100	1,999,000	828,530
49	150.72	-	31,953,000	51,624,000	4,809,500	1,924,500	783,150
50	152.56	-	31,953,000	51,624,000	4,537,200	1,782,000	711,950
51	154.42	-	31,953,000	51,624,000	4,280,400	1,650,000	647,230
52	156.30	-	31,953,000	51,624,000	4,038,100	1,527,700	588,390
53	158.21	-	31,953,000	51,624,000	3,809,600	1,414,600	534,900
54	159.97	-	31,953,000	51,624,000	3,593,900	1,309,800	486,270
55	161.94	-	31,953,000	51,624,000	3,390,500	1,212,800	442,070
56	163.93	-	31,953,000	51,624,000	3,198,600	1,122,900	401,880

Reference Year	Water Demand (Mm ³)	Capital Cost	Electricity - Pumping Cost	Maintenance Cost	NPV at 6% Discount Rate	NPV at 8% Discount Rate	NPV at 10% Discount Rate
57	165.94	-	31,953,000	51,624,000	3,017,500	1,039,800	365,340
58	167.98	-	31,953,000	51,624,000	2,846,700	962,740	332,130
59	170.05	-	31,953,000	51,624,000	2,685,600	891,420	301,940
60	172.14	-	31,953,000	51,624,000	2,533,600	825,390	274,490
61	174.26	-	31,953,000	51,624,000	2,390,200	764,250	249,530
62	176.40	-	31,953,000	51,624,000	2,254,900	707,640	226,850
63	178.57	-	31,953,000	51,624,000	2,127,200	655,220	206,230
					10,572,000,000	10,277,000,000	10,095,000,000

4.4 OPTION 2A

Option 2A consists of a single pump station and a single break pressure reservoir on the line. The pump station PS1 is positioned at chainage 8 km at an elevation of 1063.832 m. The break pressure reservoir BPT2 is positioned at chainage 330 km at an elevation of 1136.405 m. The pipeline follows R1. The MFD illustrating the transfer scheme is provided in **Figure 4-6**. The longitudinal profile of the pipeline together with the position of the pump station and all the reservoirs is illustrated in **Figure 4-7**. The hydraulic grade-line for the option is also illustrated in this figure. The hydraulic system components as sized according to the procedure described in Methodology are summarised in **Figure 4-10**: Option 3A MFD

The hydraulic calculations are provided electronically in Option 2A excel sheets on the supporting CD.

Table 4-11: Option 2A Hydraulic Components

Item	Chainage (km)	Value	
Pipeline	0-8	2.2	m - Diameter
Pump Station	8	200	m - Pumping Head
Pipeline	8-330	2.2	m - Diameter
Break Pressure	330	10	m - Elevation
Pipeline	330-472	1.8	m - Diameter
Pipeline	472-486	2.0	m -Diameter
Pipeline	486-508	1.8	m -Diameter
Pipeline	508-520	1.5	m -Diameter

The capital costs as calculated for the LCCA for Option 2A are provided in **Table 4-12** and the calculated maintenance costs are provided in **Table 4-13**. The electricity costs for the option are summarised in **Table 4-14**. The complete life cycle

costing calculation is provided in **Table 4-15**. The Net Present Value (NPV) for the option was calculated for the three different discount rates analysed by taking the yearly expenditure back to a 2010 present value. The calculated NPVs are compared in greater detail in Option Comparison. Option 2A's LCCA calculations are provided electronically in Option 2A LCCA excel sheets.

Table 4-12: Option 2A Capital Costs

Option 2A Capital Costs (Pula)	
Pipe Cost	7,210,000,000.00
Pipe Laying and Joining	1,450,000,000.00
Pipe Trench Excavation & Back Fill	830,000,000.00
Air Valve, Scour Valve & Isolating Cost	370,000,000.00
Pump Station Cost PS 1	76,300,000.00
Reservoir Cost BPT 2	2,600,000.00
Total	9,938,900,000.00

Table 4-13: Option 2A Maintenance Costs

Option 2A Maintenance Costs (Pula)		
Item	Percentage Per Annum	Cost P/year
Civil	0.50%	36,100,000.00
Mechanical & Electrical	4%	18,000,000.00
Total		54,100,000.00

Table 4-14: Option 2A Energy Costs Summary

Pipe Type	Energy Cost Per Year (Pula)
New Pipe	25,000,000.00
Average Pipe	26,100,000.00
Old Pipe	28,400,000.00
Biofilm Pipe	32,000,000.00

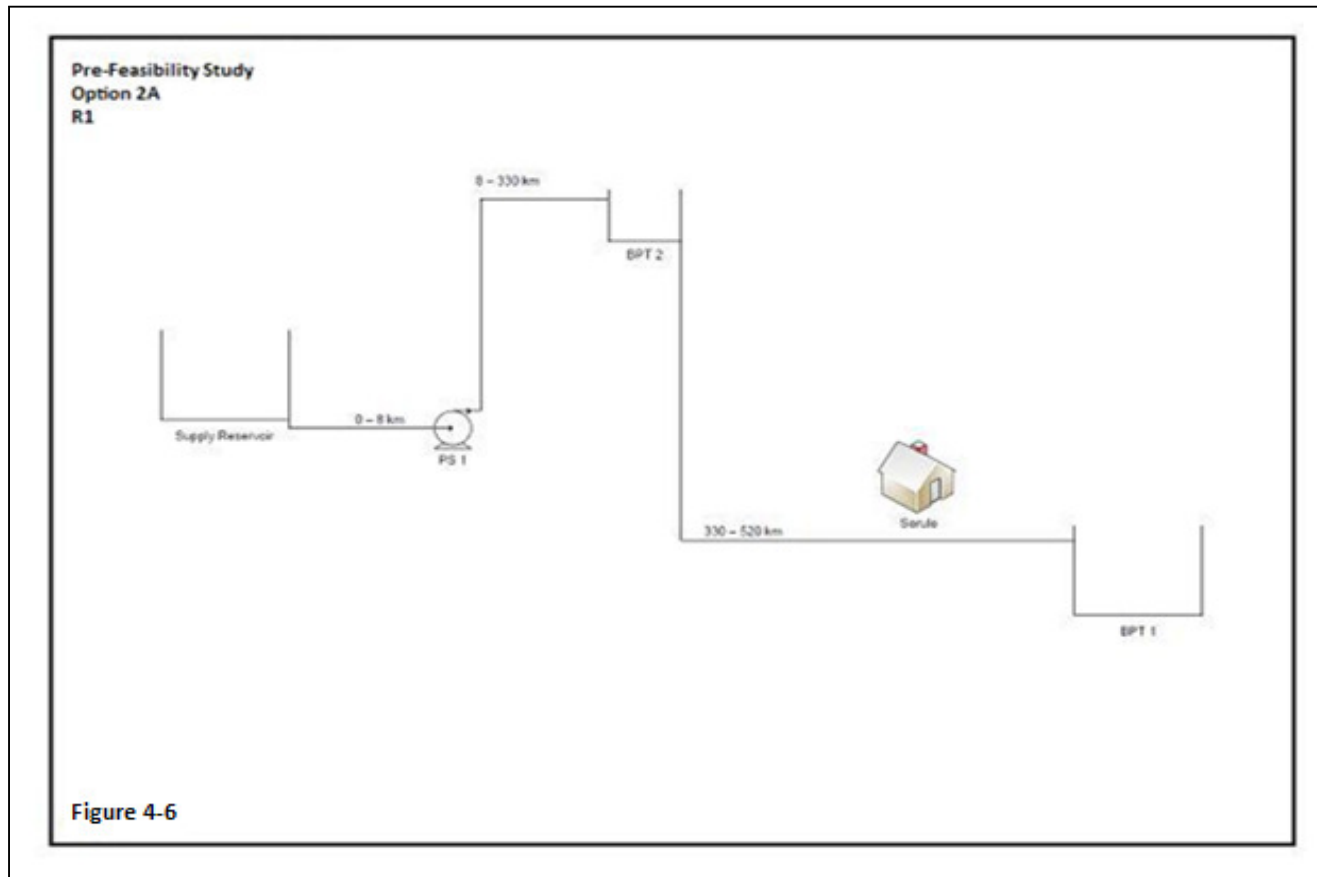

Figure 4-6: Option 2A MFD

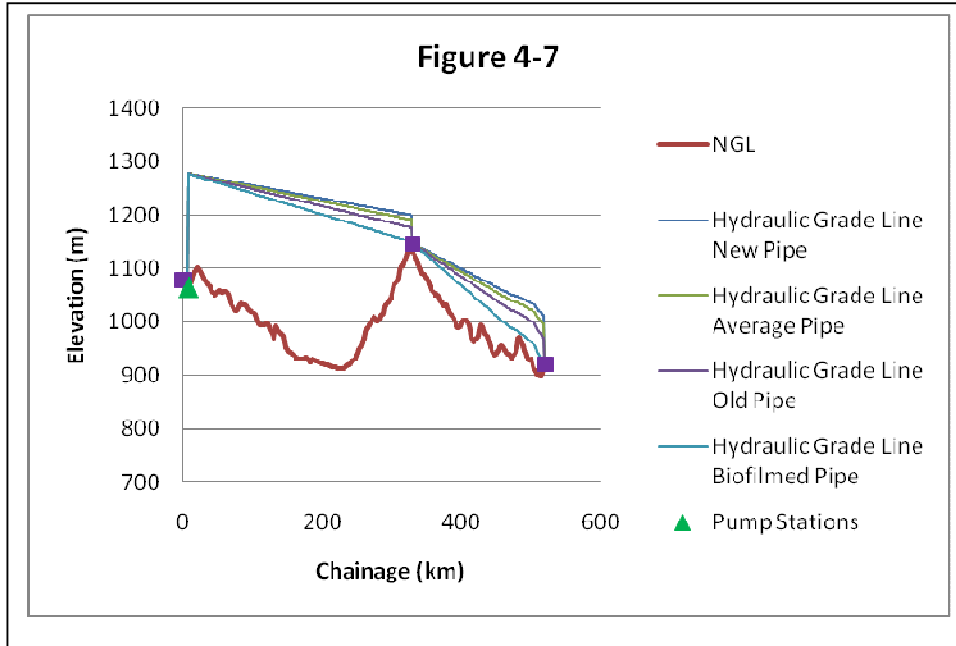

Figure 4-7: Option 2A Longitudinal and Energy Profile

Table 4-15: Option 2A Life Cycle Costing

Table 4-15: Option 2A Life Cycle Costing (Pula)							
Reference Year	Water Demand (Mm ₃)	Capital Cost	Electricity - Pumping Cost	Maintenance Cost	NPV at 6% Discount Rate	NPV at 8% Discount Rate	NPV at 10% Discount Rate
0	69.80	2,478,800,000			2,478,800,000	2,478,800,000	2,478,800,000
1	70.66	2,478,800,000			2,478,800,000	2,478,800,000	2,478,800,000
2	71.57	2,478,800,000			2,478,800,000	2,478,800,000	2,478,800,000
3	73.23	2,478,800,000			2,478,800,000	2,478,800,000	2,478,800,000
4	74.19	-	24,896,000	53,645,000	62,212,000	57,730,000	53,645,000
5	74.64	-	24,896,000	53,645,000	58,691,000	53,454,000	48,768,000
6	75.58	-	24,896,000	53,645,000	55,369,000	49,494,000	44,335,000
7	76.56	-	24,896,000	53,645,000	52,234,000	45,828,000	40,304,000
8	77.56	-	24,896,000	53,645,000	49,278,000	42,433,000	36,640,000
9	78.56	-	24,896,000	53,645,000	46,489,000	39,290,000	33,309,000
10	79.58	-	24,896,000	53,645,000	43,857,000	36,380,000	30,281,000
11	80.57	-	24,896,000	53,645,000	41,375,000	33,685,000	27,528,000
12	81.62	-	24,896,000	53,645,000	39,033,000	31,190,000	25,026,000
13	82.68	-	24,896,000	53,645,000	36,823,000	28,879,000	22,751,000
14	83.76	-	24,896,000	53,645,000	34,739,000	26,740,000	20,682,000
15	84.84	-	24,896,000	53,645,000	32,773,000	24,760,000	18,802,000
16	85.93	-	24,896,000	53,645,000	30,918,000	22,925,000	17,093,000
17	87.07	-	24,896,000	53,645,000	29,167,000	21,227,000	15,539,000

Table 4-15: Option 2A Life Cycle Costing (Pula)							
Reference Year	Water Demand (Mm ₃)	Capital Cost	Electricity - Pumping Cost	Maintenance Cost	NPV at 6% Discount Rate	NPV at 8% Discount Rate	NPV at 10% Discount Rate
18	88.16	-	24,896,000	53,645,000	27,516,000	19,655,000	14,126,000
19	89.31	-	26,228,000	53,645,000	26,399,000	18,507,000	13,060,000
20	90.43	-	26,228,000	53,645,000	24,905,000	17,137,000	11,873,000
21	91.54	-	26,228,000	53,645,000	23,495,000	15,867,000	10,793,000
22	92.66	-	26,228,000	53,645,000	22,165,000	14,692,000	9,812,000
23	93.05	-	26,228,000	53,645,000	20,910,000	13,604,000	8,920,000
24	94.20	-	26,228,000	53,645,000	19,727,000	12,596,000	8,109,100
25	104.50	-	26,228,000	53,645,000	18,610,000	11,663,000	7,371,900
26	105.77	-	26,228,000	53,645,000	17,557,000	10,799,000	6,701,800
27	107.05	-	26,228,000	53,645,000	16,563,000	9,999,000	6,092,500
28	108.35	-	26,228,000	53,645,000	15,626,000	9,258,300	5,538,600
29	109.67	-	26,228,000	53,645,000	14,741,000	8,572,500	5,035,100
30	113.75	-	26,228,000	53,645,000	13,907,000	7,937,500	4,577,400
31	115.13	-	26,228,000	53,645,000	13,119,000	7,349,600	4,161,300
32	116.53	-	26,228,000	53,645,000	12,377,000	6,805,200	3,783,000
33	117.95	-	26,228,000	53,645,000	11,676,000	6,301,100	3,439,100
34	119.38	-	28,358,000	53,645,000	11,309,000	5,989,900	3,209,800
35	122.97	-	28,358,000	53,645,000	10,669,000	5,546,200	2,918,000
36	124.47	-	28,358,000	53,645,000	10,065,000	5,135,400	2,652,700
37	125.98	-	28,358,000	53,645,000	9,495,400	4,755,000	2,411,600
38	127.51	-	28,358,000	53,645,000	8,957,900	4,402,800	2,192,300
39	129.07	-	28,358,000	53,645,000	8,450,800	4,076,600	1,993,000
40	132.24	-	28,358,000	53,645,000	7,972,500	3,774,700	1,811,800
41	133.85	-	28,358,000	53,645,000	7,521,200	3,495,100	1,647,100
42	135.48	-	28,358,000	53,645,000	7,095,500	3,236,200	1,497,400
43	137.13	-	28,358,000	53,645,000	6,693,900	2,996,500	1,361,300
44	141.48	-	28,358,000	53,645,000	6,315,000	2,774,500	1,237,500
45	143.20	-	28,358,000	53,645,000	5,957,500	2,569,000	1,125,000
46	144.95	-	28,358,000	53,645,000	5,620,300	2,378,700	1,022,700
47	146.71	-	28,358,000	53,645,000	5,302,200	2,202,500	929,760
48	148.50	-	28,358,000	53,645,000	5,002,000	2,039,300	845,240
49	150.72	-	31,686,000	53,645,000	4,910,400	1,964,900	799,590
50	152.56	-	31,686,000	53,645,000	4,632,500	1,819,400	726,900
51	154.42	-	31,686,000	53,645,000	4,370,300	1,684,600	660,820
52	156.30	-	31,686,000	53,645,000	4,122,900	1,559,800	600,740
53	158.21	-	31,686,000	53,645,000	3,889,500	1,444,300	546,130
54	159.97	-	31,686,000	53,645,000	3,669,400	1,337,300	496,480
55	161.94	-	31,686,000	53,645,000	3,461,700	1,238,200	451,350
56	163.93	-	31,686,000	53,645,000	3,265,700	1,146,500	410,320
57	165.94	-	31,686,000	53,645,000	3,080,900	1,061,600	373,010
58	167.98	-	31,686,000	53,645,000	2,906,500	982,950	339,100

Reference Year	Water Demand (Mm ₃)	Capital Cost	Electricity - Pumping Cost	Maintenance Cost	NPV at 6% Discount Rate	NPV at 8% Discount Rate	NPV at 10% Discount Rate
59	170.05	-	31,686,000	53,645,000	2,742,000	910,140	308,280
60	172.14	-	31,686,000	53,645,000	2,586,800	842,720	280,250
61	174.26	-	31,686,000	53,645,000	2,440,300	780,300	254,770
62	176.40	-	31,686,000	53,645,000	2,302,200	722,500	231,610
63	178.57	-	31,686,000	53,645,000	2,171,900	668,980	210,560
					10,994,000,000	10,693,000,000	10,507,000,000

4.5 OPTION 2B

Option 2B consists of a single pump station and a single break pressure reservoir on the line. The pump station PS1 is positioned at chainage 8 km at an elevation of 1063.832 m. The break pressure reservoir BPT2 is positioned at chainage 330 km at an elevation of 1136.405 m. The pipeline follows R2. The MFD illustrating the transfer scheme is provided in **Figure 4-8**. The longitudinal profile of the pipeline together with the position of the pump station and all the reservoirs is illustrated in **Figure 4-9**. The hydraulic grade-line for the option is also illustrated in this figure. The hydraulic system components as sized according to the procedure described in Methodology are summarised in **Table 4-16**. The hydraulic calculations are provided electronically in Option 2B excel sheets on the supporting CD.

Table 4-16: Option 2B Hydraulic Components

Item	Name	Chainage (km)	Value	
Pipeline	P1	0-8	2.2	m - Diameter
Pump Station	PS1	8	200	m - Pumping Head
Pipeline	P2	8-330	1.2	m - Diameter
Break Pressure	BPT2	330	10	m - Elevation
Pipeline	P3	330-482	1.8	m - Diameter
Pipeline	P4	482-500	1.5	m - Diameter

The capital costs as calculated for the LCCA for Option 2B are provided in **Table 4-17** and the calculated maintenance costs are provided in **Table 4-18**. The electricity costs for the option are summarised in **Table 4-19**. The complete life cycle costing calculation is provided in **Table 4-20**. The Net Present Value (NPV) for the option was calculated for the three different discount rates analysed by taking the yearly expenditure back to a 2010 present value. The calculated NPVs are compared in greater detail in Option Comparison. Option 2B's LCCA calculations are provided electronically in Option 2B LCC excel sheets.

Table 4-17: Option 2B Capital Costs

Option 2B Capital Costs (Pula)	
Pipe Cost	7,010,000,000.00
Pipe Laying and Joining	1,001,000,000.00
Pipe Trench Excavation & Back Fill	800,000,000.00
Air Valve, Scour Valve & Isolating Cost	350,700,000.00
Pump Station Cost PS 1	76,230,000.00
Reservoir Cost BPT 2	2,600,000.00
Total	9,240,530,000.00

Table 4-18: Option 2B Maintenance Costs

Option 2B Maintenance Costs (Pula)		
Item	Percentage Per Annum	Cost P/year
Civil	0.50%	35,060,000.00
Mechanical & Electrical	4%	20,700,000.00
Total		55,760,000.00

Table 4-19: Option 2B Energy Costs Summary

Pipe Type	Energy Cost Per Year (Pula)
New Pipe	24,900,000.00
Average Pipe	26,400,000.00
Old Pipe	28,400,000.00
Biofilm Pipe	31,700,000.00

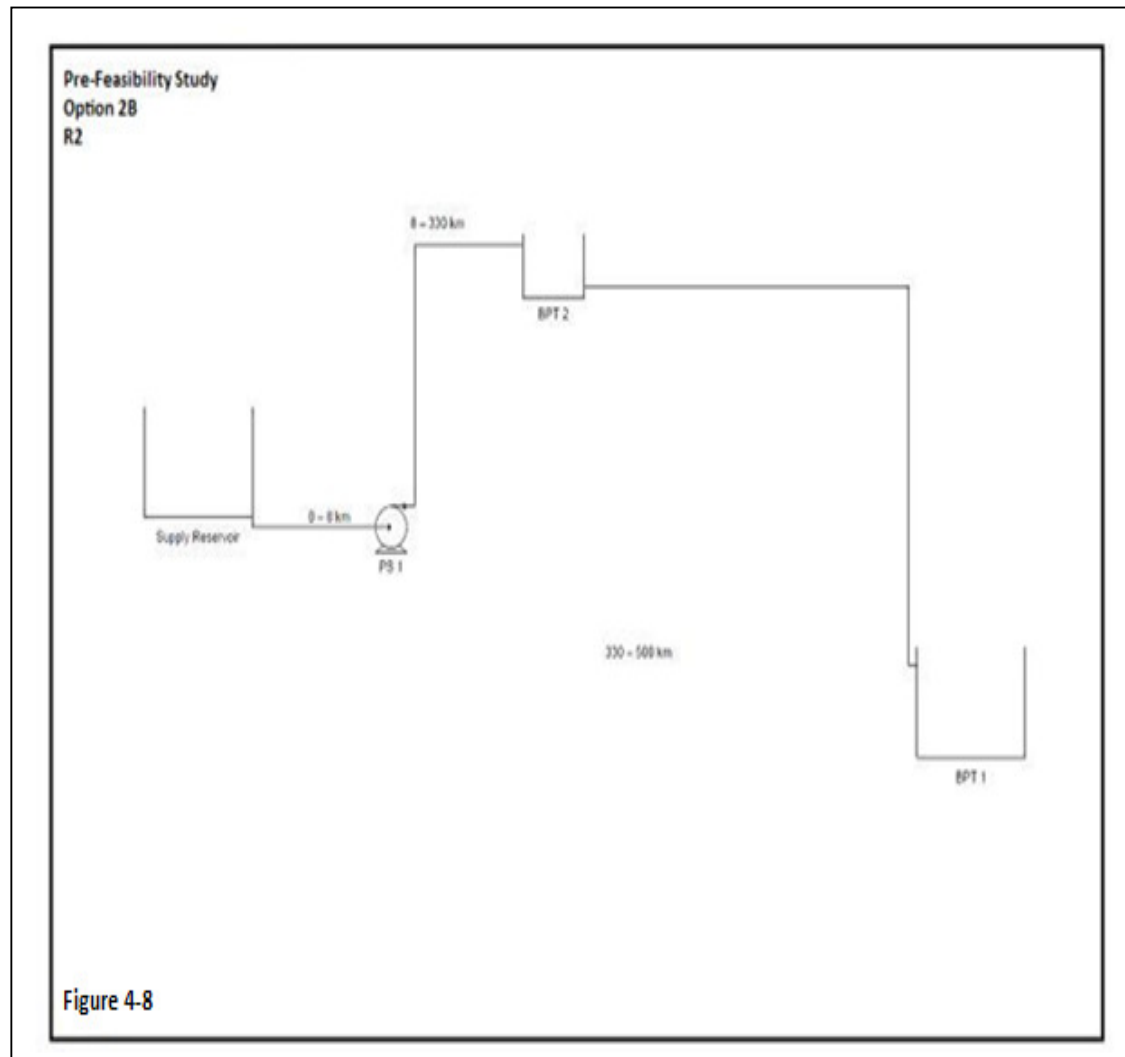

Figure 4-8: Option 2B MFD

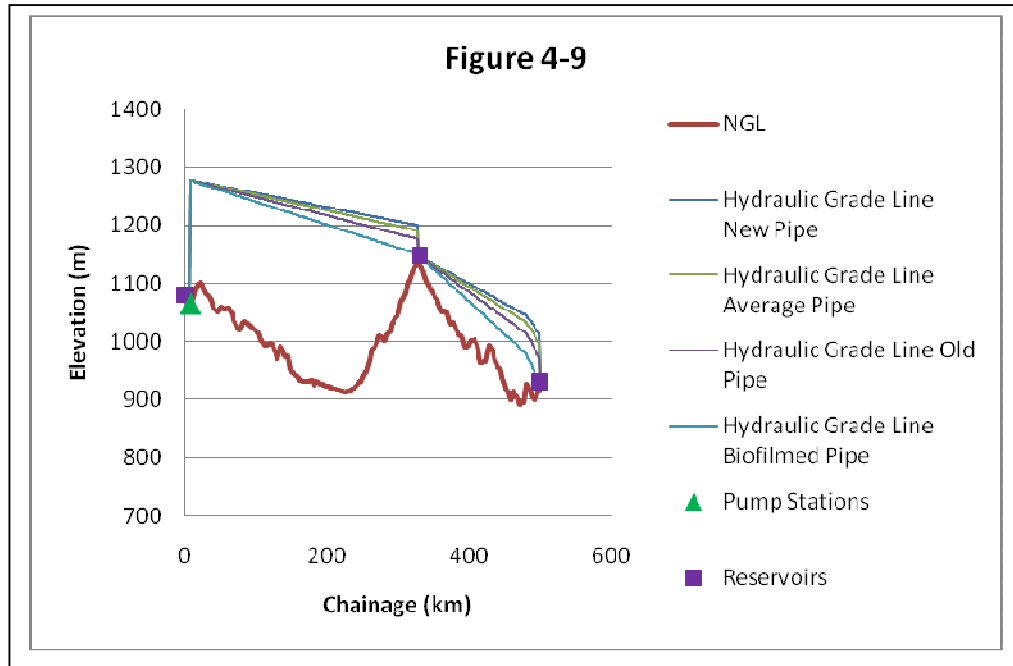

Figure 4-9: Option 2B Longitudinal and Energy Profile

Table 4-20: Option 2B Life Cycle Costing

Table 4-20: Option 2B Life Cycle Costing (Pula)							
Reference Year	Water Demand (Mm ₃)	Capital Cost	Electricity - Pumping Cost	Maintenance Cost	NPV at 6% Discount Rate	NPV at 8% Discount Rate	NPV at 10% Discount Rate
0	69.8	2,409,600,000			2,409,600,000	2,409,600,000	2,409,600,000
1	70.66	2,409,600,000			2,409,600,000	2,409,600,000	2,409,600,000
2	71.57	2,409,600,000			2,409,600,000	2,409,600,000	2,409,600,000
3	73.23	2,409,600,000			2,409,600,000	2,409,600,000	2,409,600,000
4	74.19	-	24,896,000	52,136,000	57,563,000	52,427,000	47,831,000
5	74.64	-	24,896,000	52,136,000	54,305,000	48,543,000	43,483,000
6	75.58	-	24,896,000	52,136,000	51,231,000	44,948,000	39,530,000
7	76.56	-	24,896,000	52,136,000	48,331,000	41,618,000	35,936,000
8	77.56	-	24,896,000	52,136,000	45,595,000	38,535,000	32,669,000
9	78.56	-	24,896,000	52,136,000	43,014,000	35,681,000	29,699,000
10	79.58	-	24,896,000	52,136,000	40,580,000	33,038,000	26,999,000
11	80.57	-	24,896,000	52,136,000	38,283,000	30,591,000	24,545,000
12	81.62	-	24,896,000	52,136,000	36,116,000	28,325,000	22,314,000
13	82.68	-	24,896,000	52,136,000	34,071,000	26,227,000	20,285,000
14	83.76	-	24,896,000	52,136,000	32,143,000	24,284,000	18,441,000
15	84.84	-	24,896,000	52,136,000	30,324,000	22,485,000	16,764,000

Table 4-20: Option 2B Life Cycle Costing (Pula)							
Reference Year	Water Demand (Mm ³)	Capital Cost	Electricity - Pumping Cost	Maintenance Cost	NPV at 6% Discount Rate	NPV at 8% Discount Rate	NPV at 10% Discount Rate
16	85.93	-	24,896,000	52,136,000	28,607,000	20,819,000	15,240,000
17	87.07	-	24,896,000	52,136,000	26,988,000	19,277,000	13,855,000
18	88.16	-	26,361,000	52,136,000	25,944,000	18,189,000	12,835,000
19	89.31	-	26,361,000	52,136,000	24,476,000	16,841,000	11,668,000
20	90.43	-	26,361,000	52,136,000	23,090,000	15,594,000	10,607,000
21	91.54	-	26,361,000	52,136,000	21,783,000	14,439,000	9,643,000
22	92.66	-	26,361,000	52,136,000	20,550,000	13,369,000	8,766,400
23	93.05	-	26,361,000	52,136,000	19,387,000	12,379,000	7,969,400
24	94.2	-	26,361,000	52,136,000	18,290,000	11,462,000	7,244,900
25	104.5	-	26,361,000	52,136,000	17,254,000	10,613,000	6,586,300
26	105.77	-	26,361,000	52,136,000	16,278,000	9,826,800	5,987,600
27	107.05	-	26,361,000	52,136,000	15,356,000	9,098,900	5,443,200
28	108.35	-	26,361,000	52,136,000	14,487,000	8,424,900	4,948,400
29	109.67	-	26,361,000	52,136,000	13,667,000	7,800,800	4,498,500
30	113.75	-	26,361,000	52,136,000	12,893,000	7,223,000	4,089,600
31	115.13	-	26,361,000	52,136,000	12,164,000	6,687,900	3,717,800
32	116.53	-	26,361,000	52,136,000	11,475,000	6,192,500	3,379,800
33	117.95	-	28,358,000	52,136,000	11,101,000	5,879,700	3,150,700
34	119.38	-	28,358,000	52,136,000	10,473,000	5,444,200	2,864,300
35	122.97	-	28,358,000	52,136,000	9,879,900	5,040,900	2,603,900
36	124.47	-	28,358,000	52,136,000	9,320,600	4,667,500	2,367,200
37	125.98	-	28,358,000	52,136,000	8,793,100	4,321,800	2,152,000
38	127.51	-	28,358,000	52,136,000	8,295,300	4,001,600	1,956,400
39	129.07	-	28,358,000	52,136,000	7,825,800	3,705,200	1,778,500
40	132.24	-	28,358,000	52,136,000	7,382,800	3,430,700	1,616,800
41	133.85	-	28,358,000	52,136,000	6,964,900	3,176,600	1,469,800
42	135.48	-	28,358,000	52,136,000	6,570,700	2,941,300	1,336,200
43	137.13	-	28,358,000	52,136,000	6,198,800	2,723,400	1,214,700
44	141.48	-	28,358,000	52,136,000	5,847,900	2,521,700	1,104,300
45	143.2	-	28,358,000	52,136,000	5,516,900	2,334,900	1,003,900
46	144.95	-	28,358,000	52,136,000	5,204,600	2,162,000	912,650
47	146.71	-	28,358,000	52,136,000	4,910,000	2,001,800	829,690
48	148.5	-	31,686,000	52,136,000	4,823,600	1,930,200	785,450
49	150.72	-	31,686,000	52,136,000	4,550,600	1,787,200	714,040
50	152.56	-	31,686,000	52,136,000	4,293,000	1,654,800	649,130
51	154.42	-	31,686,000	52,136,000	4,050,000	1,532,200	590,120
52	156.3	-	31,686,000	52,136,000	3,820,700	1,418,700	536,470
53	158.21	-	31,686,000	52,136,000	3,604,500	1,313,600	487,700
54	159.97	-	31,686,000	52,136,000	3,400,500	1,216,300	443,370
55	161.94	-	31,686,000	52,136,000	3,208,000	1,126,200	403,060
56	163.93	-	31,686,000	52,136,000	3,026,400	1,042,800	366,420

Reference Year	Water Demand (Mm ₃)	Capital Cost	Electricity - Pumping Cost	Maintenance Cost	NPV at 6% Discount Rate	NPV at 8% Discount Rate	NPV at 10% Discount Rate
57	165.94	-	31,686,000	52,136,000	2,855,100	965,560	333,110
58	167.98	-	31,686,000	52,136,000	2,693,500	894,040	302,820
59	170.05	-	31,686,000	52,136,000	2,541,000	827,820	275,290
60	172.14	-	31,686,000	52,136,000	2,397,200	766,500	250,270
61	174.26	-	31,686,000	52,136,000	2,261,500	709,720	227,520
62	176.4	-	31,686,000	52,136,000	2,133,500	657,150	206,830
					10,697,000,000	10,402,000,000	10,219,000,000

4.6 OPTION 3A

Option 3A consists of two pump stations and two break pressure reservoirs on the line. Pump station PS1 is positioned at chainage 8 km at an elevation of 1063.832 m and pump station PS2 is positioned at chainage 274 km at an elevation of 1008.819 m. Break pressure reservoir BPT3 is positioned at chainage 22 km at an elevation of 1101.67 m and break pressure reservoir BPT4 is positioned at chainage 274 km at an elevation of 1008.819. The pipeline follows R1. The MFD illustrating the transfer scheme is provided in **Figure 4-10**. The longitudinal profile of the pipeline together with the position of the pump station and all the reservoirs is illustrated in **Figure 4-10**. The hydraulic grade-line for the option is also illustrated in this figure. The hydraulic system components as sized according to the procedure described in Methodology are summarised in **Table 4-21**. The hydraulic calculations are provided electronically in Option 3A excel sheets on the supporting CD.

Table 4-21: Option 3A Hydraulic Components

Item	Chainage (km)	Value	
Pipeline	0-8	1.9	m - Diameter
Pump Station	8	50	m - Pumping Head
Pipeline	8-22	1.9	m - Diameter
Break Pressure	22	10	m -Elevation
Pipeline	22-274	2.2	m - Diameter
Break Pressure	274	10	m - Elevation
Pump Station	274	160	m - Pumping Head
Pipeline	274-336	2.2	m -Diameter
Pipeline	336-508	1.8	m -Diameter
Pipeline	508-520	1.5	m -Diameter

The capital costs as calculated for the LCCA for Option 3A are provided in **Table 4-22** and the calculated maintenance costs are provided in **Table 4-23**. The electricity costs for the option are summarised in **Table 4-24**. The complete life cycle

costing calculation is provided in **Table 4-25**. The Net Present Value (NPV) for the option was calculated for the three different discount rates analysed by taking the yearly expenditure back to a 2010 present value. The calculated NPVs are compared in greater detail in Option Comparison. Option 3A's LCCA calculations are provided electronically in Option 3A LCCA excel sheets.

Table 4-22: Option 3A Capital Costs

Option 3A Capital Costs (Pula)	
Pipe Cost	6,000,000,000.00
Pipe Laying and Joining	1,200,000,000.00
Pipe Trench Excavation & Back Fill	824,000,000.00
Air Valve, Scour Valve & Isolating Cost	362,000,000.00
Pump Station Cost PS 1	29,000,000.00
Pump Station Cost PS 2	65,300,000.00
Reservoir Cost BPT 3	3,000,000.00
Reservoir Cost BPT 4	2,600,000.00
Total	8,485,900,000.00

Table 4-23: Option 3A Maintenance Costs

Option3A Maintenance Costs (Pula)		
Item	Percentage Per Annum	Cost P/year
Civil	0.50%	30,000,000.00
Mechanical & Electrical	4%	18,300,000.00
Total		48,300,000.00

Table 4-24: Option 3A Energy Costs Summary

Pipe Type	Energy Cost Per Year PS 1 (Pula)	Energy Cost Per Year PS 2 (Pula)
New Pipe	6,200,000.00	20,023,000.00
Average Pipe	6,500,000.00	21,200,000.00
Old Pipe	7,024,000.00	23,000,000.00
Biofilm Pipe	7,900,000.00	25,600,000.00

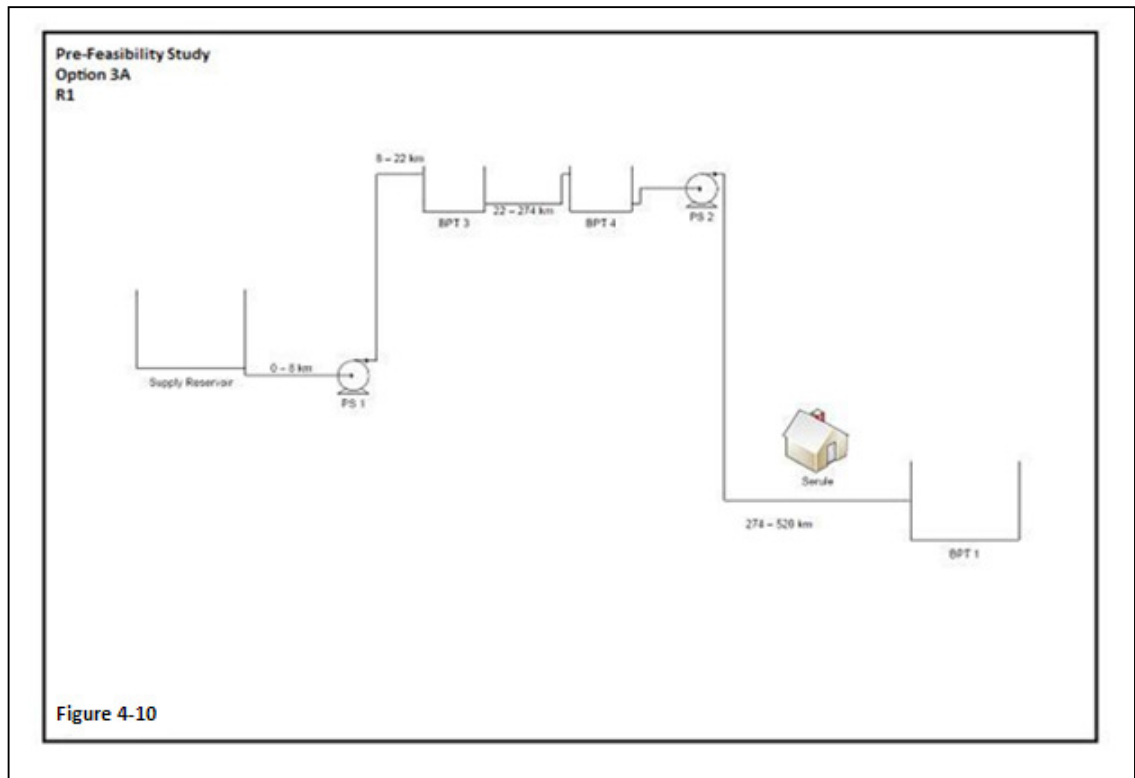

Figure 4-10: Option 3A MFD

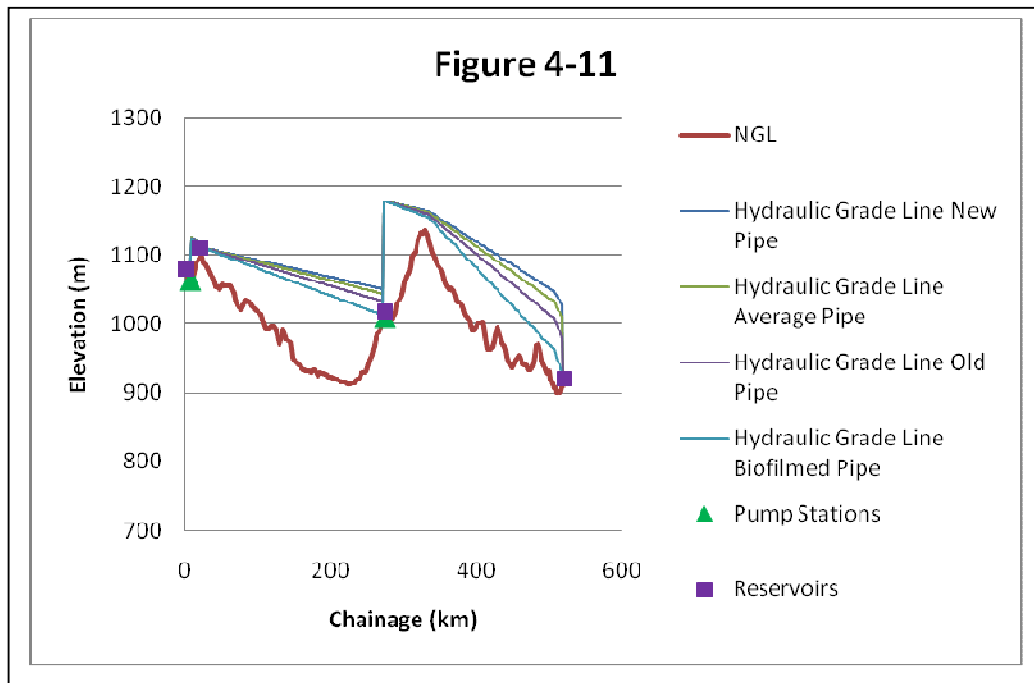

Figure 4-11: Option 3A Longitudinal and Energy Profile

Table 4-25: Option 3A Life Cycle Costing

Table 4-25: Option 3A Life Cycle Costing (Pula)							
Reference Year	Water Demand (Mm ³)	Capital Cost	Electricity - Pumping Cost	Maintenance Cost	NPV at 6% Discount Rate	NPV at 8% Discount Rate	NPV at 10% Discount Rate
0	69.8	2,106,400,000			2,106,400,000	2,106,400,000	2,106,400,000
1	70.66	2,106,400,000			2,106,400,000	2,106,400,000	2,106,400,000
2	71.57	2,106,400,000			2,106,400,000	2,106,400,000	2,106,400,000
3	73.23	2,106,400,000			2,106,400,000	2,106,400,000	2,106,400,000
4	74.19	-	26,181,000	48,005,000	58,762,000	54,528,000	50,669,000
5	74.64	-	26,181,000	48,005,000	55,435,000	50,489,000	46,063,000
6	75.58	-	26,181,000	48,005,000	52,298,000	46,749,000	41,876,000
7	76.56	-	26,181,000	48,005,000	49,337,000	43,286,000	38,069,000
8	77.56	-	26,181,000	48,005,000	46,545,000	40,080,000	34,608,000
9	78.56	-	26,181,000	48,005,000	43,910,000	37,111,000	31,462,000
10	79.58	-	26,181,000	48,005,000	41,425,000	34,362,000	28,602,000
11	80.57	-	26,181,000	48,005,000	39,080,000	31,817,000	26,001,000
12	81.62	-	26,181,000	48,005,000	36,868,000	29,460,000	23,638,000
13	82.68	-	26,181,000	48,005,000	34,781,000	27,278,000	21,489,000
14	83.76	-	26,181,000	48,005,000	32,812,000	25,257,000	19,535,000
15	84.84	-	26,181,000	48,005,000	30,955,000	23,386,000	17,759,000
16	85.93	-	26,181,000	48,005,000	29,203,000	21,654,000	16,145,000
17	87.07	-	26,181,000	48,005,000	27,550,000	20,050,000	14,677,000
18	88.16	-	26,181,000	48,005,000	25,990,000	18,565,000	13,343,000
19	89.31	-	27,685,000	48,005,000	25,016,000	17,538,000	12,376,000
20	90.43	-	27,685,000	48,005,000	23,600,000	16,239,000	11,251,000
21	91.54	-	27,685,000	48,005,000	22,264,000	15,036,000	10,228,000
22	92.66	-	27,685,000	48,005,000	21,004,000	13,922,000	9,298,200
23	93.05	-	27,685,000	48,005,000	19,815,000	12,891,000	8,452,900
24	94.2	-	27,685,000	48,005,000	18,694,000	11,936,000	7,684,400
25	104.5	-	27,685,000	48,005,000	17,636,000	11,052,000	6,985,800
26	105.77	-	27,685,000	48,005,000	16,637,000	10,233,000	6,350,800
27	107.05	-	27,685,000	48,005,000	15,696,000	9,475,300	5,773,400
28	108.35	-	27,685,000	48,005,000	14,807,000	8,773,500	5,248,600
29	109.67	-	27,685,000	48,005,000	13,969,000	8,123,600	4,771,400
30	113.75	-	27,685,000	48,005,000	13,178,000	7,521,800	4,337,700
31	115.13	-	27,685,000	48,005,000	12,432,000	6,964,700	3,943,300
32	116.53	-	27,685,000	48,005,000	11,729,000	6,448,800	3,584,800
33	117.95	-	27,685,000	48,005,000	11,065,000	5,971,100	3,258,900
34	119.38	-	29,921,000	48,005,000	10,747,000	5,692,100	3,050,200
35	122.97	-	29,921,000	48,005,000	10,139,000	5,270,500	2,772,900
36	124.47	-	29,921,000	48,005,000	9,564,700	4,880,100	2,520,800
37	125.98	-	29,921,000	48,005,000	9,023,300	4,518,600	2,291,700
38	127.51	-	29,921,000	48,005,000	8,512,600	4,183,900	2,083,300
39	129.07	-	29,921,000	48,005,000	8,030,700	3,874,000	1,893,900

Table 4-25: Option 3A Life Cycle Costing (Pula)							
Reference Year	Water Demand (Mm ³)	Capital Cost	Electricity - Pumping Cost	Maintenance Cost	NPV at 6% Discount Rate	NPV at 8% Discount Rate	NPV at 10% Discount Rate
40	132.24	-	29,921,000	48,005,000	7,576,100	3,587,000	1,721,800
41	133.85	-	29,921,000	48,005,000	7,147,300	3,321,300	1,565,200
42	135.48	-	29,921,000	48,005,000	6,742,700	3,075,300	1,423,000
43	137.13	-	29,921,000	48,005,000	6,361,100	2,847,500	1,293,600
44	141.48	-	29,921,000	48,005,000	6,001,000	2,636,600	1,176,000
45	143.2	-	29,921,000	48,005,000	5,661,300	2,441,300	1,069,100
46	144.95	-	29,921,000	48,005,000	5,340,900	2,260,400	971,900
47	146.71	-	29,921,000	48,005,000	5,038,600	2,093,000	883,540
48	148.5	-	29,921,000	48,005,000	4,753,400	1,938,000	803,220
49	150.72	-	33,416,000	48,005,000	4,685,400	1,874,900	762,950
50	152.56	-	33,416,000	48,005,000	4,420,200	1,736,000	693,590
51	154.42	-	33,416,000	48,005,000	4,170,000	1,607,400	630,530
52	156.3	-	33,416,000	48,005,000	3,934,000	1,488,300	573,210
53	158.21	-	33,416,000	48,005,000	3,711,300	1,378,100	521,100
54	159.97	-	33,416,000	48,005,000	3,501,200	1,276,000	473,730
55	161.94	-	33,416,000	48,005,000	3,303,000	1,181,500	430,660
56	163.93	-	33,416,000	48,005,000	3,116,100	1,094,000	391,510
57	165.94	-	33,416,000	48,005,000	2,939,700	1,012,900	355,920
58	167.98	-	33,416,000	48,005,000	2,773,300	937,900	323,560
59	170.05	-	33,416,000	48,005,000	2,616,300	868,430	294,150
60	172.14	-	33,416,000	48,005,000	2,468,200	804,100	267,410
61	174.26	-	33,416,000	48,005,000	2,328,500	744,540	243,100
62	176.4	-	33,416,000	48,005,000	2,196,700	689,390	221,000
63	178.57	-	33,416,000	48,005,000	2,072,400	638,320	200,910
					9,447,200,000	9,161,900,000	8,985,200,000

4.7 OPTION 3B

Option 3B consists of two pump stations and two break pressure reservoirs on the line. Pump station PS1 is positioned at chainage 8 km at an elevation of 1063.832 m and pump station PS2 is positioned at chainage 274 km at an elevation of 1008.819 m. Break pressure reservoir BPT3 is positioned at chainage 22 km at an elevation of 1101.67 m and break pressure reservoir BPT4 is positioned at chainage 274 km at an elevation of 1008.819. The pipeline follows R2. The MFD illustrating the transfer scheme is provided in **Figure 4-12**. The longitudinal profile of the pipeline together with the position of the pump station and all the reservoirs is illustrated in **Figure 4-13**. The hydraulic grade-line for the option is also illustrated in this figure. The hydraulic system components as sized according to the procedure described in methodology are summarised in **Table 4-26**. The hydraulic calculations are provided electronically in Option 3B excel sheets on the supporting CD.

Table 4-26: Option 3B Hydraulic Components

Option 3B Summary			
Item	Chainage (km)	Value	
Pipeline	0-8	1.9	m – Diameter
Pump Station	8	50	m - Pumping Head
Pipeline	8-22	1.9	m – Diameter
Break Pressure	22	10	m – Elevation
Pipeline	22-274	2.2	m – Diameter
Break Pressure	274	10	m –Elevation
Pump Station	274	160	m - Pumping Head
Pipeline	274-336	2.2	m –Diameter
Pipeline	336-478	1.8	m –Diameter
Pipeline	478-500	1.5	m – Diameter

Table 4-27: Option 3B Capital Costs

Option 3B Capital Costs (Pula)	
Pipe Cost	5,752,000,000.00
Pipe Laying and Joining	1,151,000,000.00
Pipe Trench Excavation & Back Fill	794,000,000.00
Air Valve, Scour Valve & Isolating Cost	350,000,000.00
Pump Station Cost PS 1	28,600,000.00
Pump Station Cost PS 2	65,240,000.00
Reservoir Cost BPT 3	2,570,000.00
Reservoir Cost BPT 4	2,570,000.00
Total	8,145,980,000.00

Table 4-28: Option 3B Maintenance Costs

Option 3B Maintenance Costs (Pula)		
Item	Percentage Per Annum	Cost P/year
Civil	0.50%	28,800,000.00
Mechanical & Electrical	4%	18,000,000.00
Total		46,510,000.00

Table 4-29: Option 3B Energy Costs Summary

Pipe Type	Energy Cost Per Year PS 1 (Pula)	Energy Cost Per Year PS 2 (Pula)
New Pipe	6,000,000.00	19,900,000.00
Average Pipe	6,325,000.00	20,981,000.00
Old Pipe	6,825,000.00	22,685,000.00
Biofilm Pipe	7,657,000.00	25,454,000.00

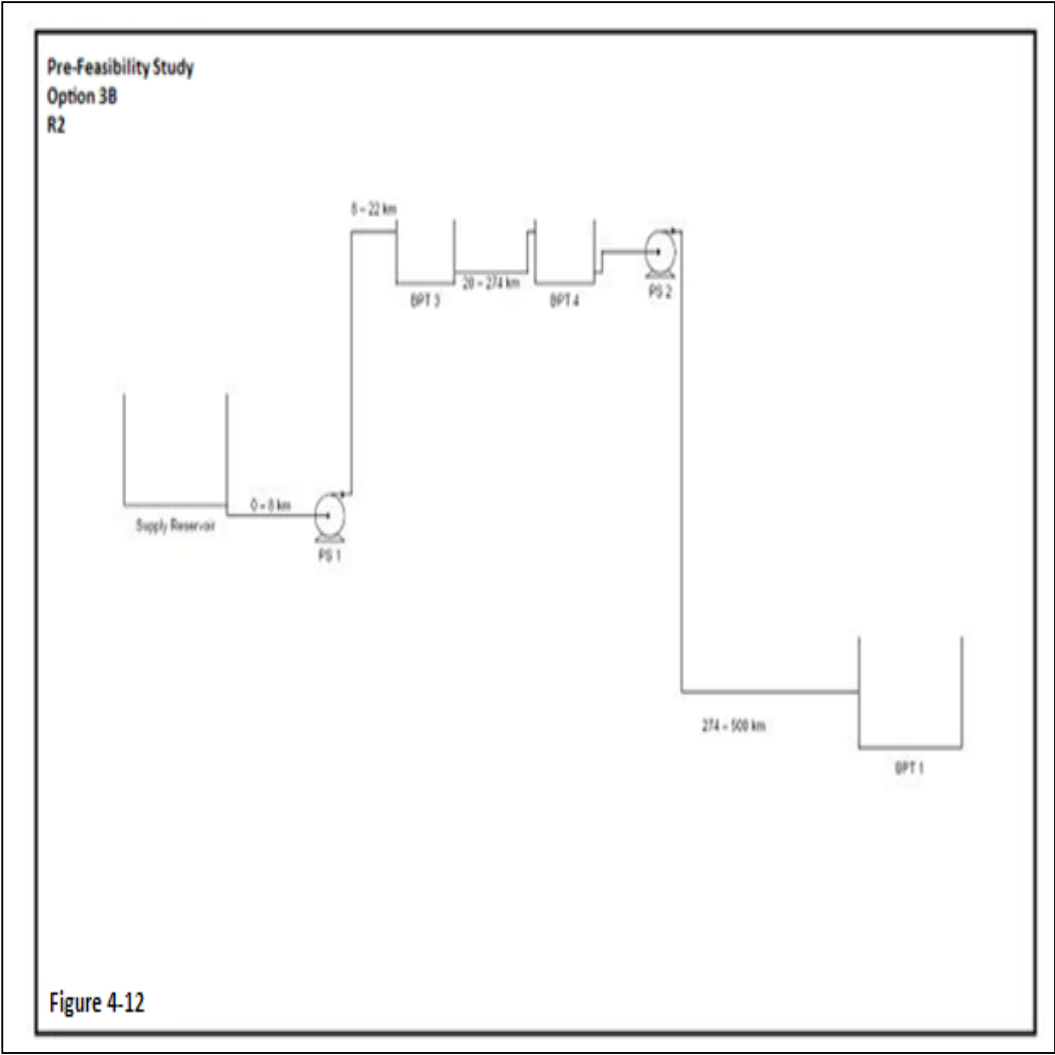

Figure 4-12: Option 3B MFD

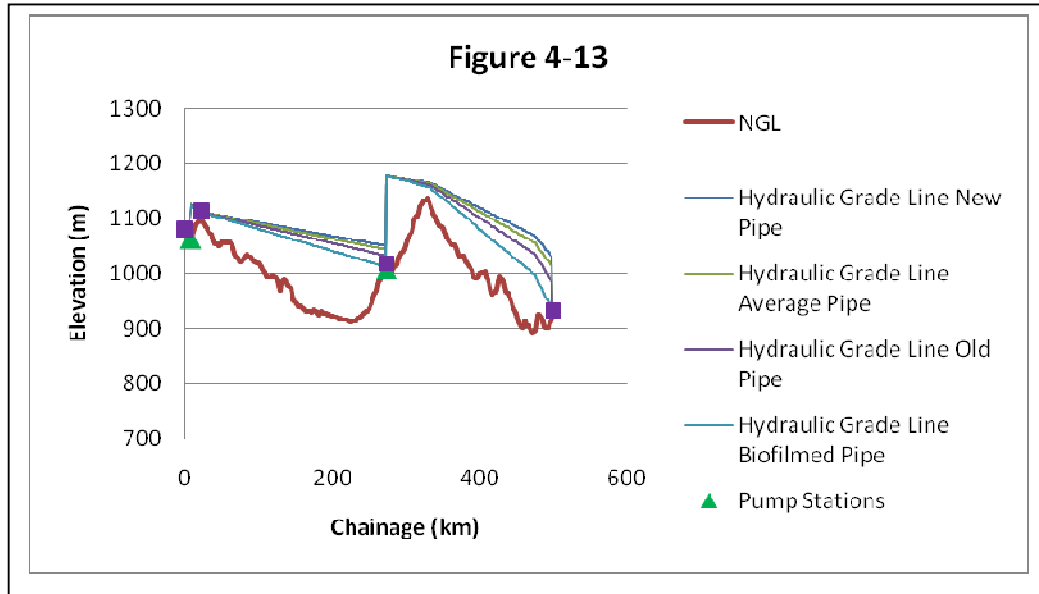

Figure 4-13: Option 3B Longitudinal and Energy Profile

Table 4-30: Option 3B Life Cycle Costing

Table 4-30: Option 3B Life Cycle Costing (Pula)							
Reference Year	Water Demand	Capital Cost	Electricity - Pumping Cost	Maintenance Cost	NPV at 6% Discount Rate	NPV at 8% Discount Rate	NPV at 10% Discount Rate
0	69.80	2,036,100,000			2,036,100,000	2,036,100,000	2,036,100,000
1	70.66	2,036,100,000			2,036,100,000	2,036,100,000	2,036,100,000
2	71.57	2,036,100,000			2,036,100,000	2,036,100,000	2,036,100,000
3	73.23	2,036,100,000			2,036,100,000	2,036,100,000	2,036,100,000
4	74.19	-	25,801,000	46,507,000	57,275,000	53,149,000	49,388,000
5	74.64	-	25,801,000	46,507,000	54,033,000	49,212,000	44,898,000
6	75.58	-	25,801,000	46,507,000	50,975,000	45,567,000	40,816,000
7	76.56	-	25,801,000	46,507,000	48,089,000	42,191,000	37,106,000
8	77.56	-	25,801,000	46,507,000	45,367,000	39,066,000	33,732,000
9	78.56	-	25,801,000	46,507,000	42,799,000	36,172,000	30,666,000
10	79.58	-	25,801,000	46,507,000	40,377,000	33,493,000	27,878,000
11	80.57	-	25,801,000	46,507,000	38,091,000	31,012,000	25,344,000
12	81.62	-	25,801,000	46,507,000	35,935,000	28,715,000	23,040,000
13	82.68	-	25,801,000	46,507,000	33,901,000	26,588,000	20,945,000
14	83.76	-	25,801,000	46,507,000	31,982,000	24,618,000	19,041,000
15	84.84	-	25,801,000	46,507,000	30,172,000	22,795,000	17,310,000
16	85.93	-	25,801,000	46,507,000	28,464,000	21,106,000	15,736,000
17	87.07	-	25,801,000	46,507,000	26,853,000	19,543,000	14,306,000
18	88.16	-	25,801,000	46,507,000	25,333,000	18,095,000	13,005,000
19	89.31	-	27,305,000	46,507,000	24,396,000	17,103,000	12,069,000

Table 4-30: Option 3B Life Cycle Costing (Pula)							
Reference Year	Water Demand	Capital Cost	Electricity - Pumping Cost	Maintenance Cost	NPV at 6% Discount Rate	NPV at 8% Discount Rate	NPV at 10% Discount Rate
20	90.43	-	27,305,000	46,507,000	23,015,000	15,836,000	10,972,000
21	91.54	-	27,305,000	46,507,000	21,712,000	14,663,000	9,974,400
22	92.66	-	27,305,000	46,507,000	20,483,000	13,577,000	9,067,600
23	93.05	-	27,305,000	46,507,000	19,324,000	12,571,000	8,243,300
24	94.20	-	27,305,000	46,507,000	18,230,000	11,640,000	7,493,900
25	104.50	-	27,305,000	46,507,000	17,198,000	10,778,000	6,812,600
26	105.77	-	27,305,000	46,507,000	16,225,000	9,979,600	6,193,300
27	107.05	-	27,305,000	46,507,000	15,306,000	9,240,400	5,630,300
28	108.35	-	27,305,000	46,507,000	14,440,000	8,555,900	5,118,400
29	109.67	-	27,305,000	46,507,000	13,623,000	7,922,200	4,653,100
30	113.75	-	27,305,000	46,507,000	12,852,000	7,335,300	4,230,100
31	115.13	-	27,305,000	46,507,000	12,124,000	6,792,000	3,845,600
32	116.53	-	27,305,000	46,507,000	11,438,000	6,288,900	3,496,000
33	117.95	-	27,305,000	46,507,000	10,790,000	5,823,000	3,178,100
34	119.38	-	29,509,000	46,507,000	10,484,000	5,552,600	2,975,500
35	122.97	-	29,509,000	46,507,000	9,890,100	5,141,300	2,705,000
36	124.47	-	29,509,000	46,507,000	9,330,300	4,760,500	2,459,100
37	125.98	-	29,509,000	46,507,000	8,802,200	4,407,900	2,235,500
38	127.51	-	29,509,000	46,507,000	8,303,900	4,081,300	2,032,300
39	129.07	-	29,509,000	46,507,000	7,833,900	3,779,000	1,847,500
40	132.24	-	29,509,000	46,507,000	7,390,500	3,499,100	1,679,600
41	133.85	-	29,509,000	46,507,000	6,972,100	3,239,900	1,526,900
42	135.48	-	29,509,000	46,507,000	6,577,500	2,999,900	1,388,100
43	137.13	-	29,509,000	46,507,000	6,205,200	2,777,700	1,261,900
44	141.48	-	29,509,000	46,507,000	5,853,900	2,571,900	1,147,200
45	143.20	-	29,509,000	46,507,000	5,522,600	2,381,400	1,042,900
46	144.95	-	29,509,000	46,507,000	5,210,000	2,205,000	948,070
47	146.71	-	29,509,000	46,507,000	4,915,100	2,041,700	861,890
48	148.50	-	29,509,000	46,507,000	4,636,900	1,890,500	783,530
49	150.72	-	33,110,000	46,507,000	4,581,600	1,833,300	746,050
50	152.56	-	33,110,000	46,507,000	4,322,300	1,697,500	678,220
51	154.42	-	33,110,000	46,507,000	4,077,600	1,571,800	616,570
52	156.30	-	33,110,000	46,507,000	3,846,800	1,455,400	560,520
53	158.21	-	33,110,000	46,507,000	3,629,100	1,347,600	509,560
54	159.97	-	33,110,000	46,507,000	3,423,700	1,247,700	463,240
55	161.94	-	33,110,000	46,507,000	3,229,900	1,155,300	421,120
56	163.93	-	33,110,000	46,507,000	3,047,000	1,069,700	382,840
57	165.94	-	33,110,000	46,507,000	2,874,600	990,500	348,040
58	167.98	-	33,110,000	46,507,000	2,711,900	917,130	316,400
59	170.05	-	33,110,000	46,507,000	2,558,400	849,190	287,630
60	172.14	-	33,110,000	46,507,000	2,413,500	786,290	261,480

Reference Year	Water Demand	Capital Cost	Electricity - Pumping Cost	Maintenance Cost	NPV at 6% Discount Rate	NPV at 8% Discount Rate	NPV at 10% Discount Rate
61	174.26	-	33,110,000	46,507,000	2,276,900	728,050	237,710
62	176.40	-	33,110,000	46,507,000	2,148,000	674,120	216,100
63	178.57	-	33,110,000	46,507,000	2,026,500	624,180	196,460
					9,140,300,000	8,862,100,000	8,689,700,000

4.8 OPTION 4A

Option 4A consists of two pump stations and two break pressure reservoirs on the line. Pump station PS1 is positioned at chainage 8 km at an elevation of 1063.832 m and pump station PS3 is positioned at chainage 228 km at an elevation of 913.484 m. Break pressure reservoir BPT3 is positioned at chainage 22 km at an elevation of 1101.67 m and break pressure reservoir BPT5 is positioned at chainage 228 km at an elevation of 913.484 m. The pipeline follows R1. The MFD illustrating the transfer scheme is provided in **Figure 4-17**. The longitudinal profile of the pipeline together with the position of the pump station and all the reservoirs is illustrated in **Figure 4-15**. The hydraulic grade-line for the option is also illustrated in this figure. The hydraulic system components as sized according to the procedure described in Methodology are summarised in **Table 4-31**. The hydraulic calculations are provided electronically in Option 4A excel sheets on the supporting CD.

Table 4-31: Option 4A Hydraulic Components

Item	Chainage (km)	Value	
Pipeline	0-8	1.9	m - Diameter
Pump Station	8	50	m - Pumping Head
Pipeline	8-22	1.9	m - Diameter
Break Pressure	22	10	m -Elevation
Pipeline	22-158	1.9	m - Diameter
Pipeline	158-228	1.8	m - Diameter
Break Pressure	228	10	m - Elevation
Pump Station	228	260	m - Pumping Head
Pipeline	228-336	2.2	m -Diameter
Pipeline	336-508	1.8	m -Diameter
Pipeline	508-520	1.5	m -Diameter

The capital costs as calculated for the LCCA for Option 4A are provided in **Table 4-32** and the calculated maintenance costs are provided in **Table 4-33**. The electricity costs for the option are summarised in **Table 4-34**. The complete life cycle costing calculation is provided in **Table 4-35**. The Net Present Value (NPV) for the option was calculated for the three different discount rates analysed by taking the yearly expenditure back to a 2010 present value. The calculated NPVs are compared

in greater detail in Option Comparison. Option 4A's LCCA calculations are provided electronically in Option 4A LCCA excel sheets.

Table 4-32: Option 4A Capital Costs

Option 4A Capital Costs (Pula)	
Pipe Cost	5,354,000,000.00
Pipe Laying and Joining	1,071,000,000.00
Pipe Trench Excavation & Back Fill	764,000,000.00
Air Valve, Scour Valve & Isolating Cost	334,500,000.00
Pump Station Cost PS 1	28,600,000.00
Pump Station Cost PS 3	96,400,000.00
Reservoir Cost BPT 3	2,600,000.00
Reservoir Cost BPT 5	2,600,000.00
Total	7,653,700,000.00

Table 4-33: Option 4A Maintenance Costs

Option 4A Maintenance Costs (Pula)		
Item	Percentage Per Annum	Cost P/year
Civil	0.50%	26,800,000.00
Mechanical & Electrical	4%	18,400,000.00
Total		45,200,000.00

Table 4-34: Option 4A Energy Costs Summary

Pipe Type	Energy Cost Per Year PS 1 (Pula)	Energy Cost Per Year PS 2 (Pula)
New Pipe	6,160,000.00	29,000,000.00
Average Pipe	6,500,000.00	30,900,000.00
Old Pipe	7,024,000.00	32,900,000.00
Biofilm Pipe	7,900,000.00	36,900,000.00

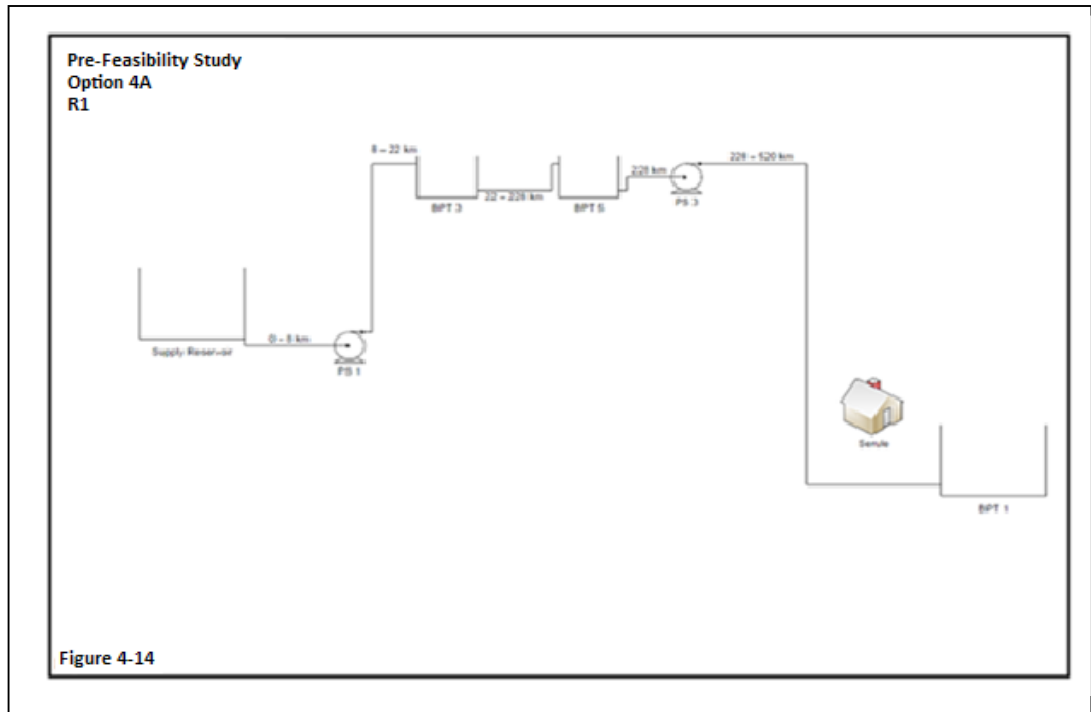

Figure 4-14: Option 4A MFD

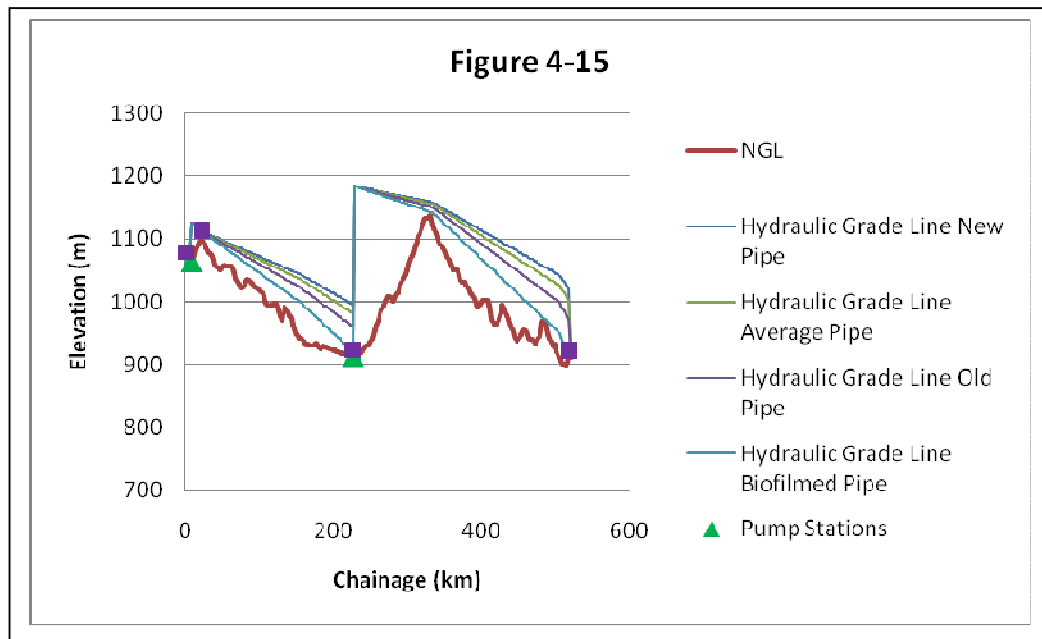

Figure 4-15: Option 4A Longitudinal and Energy Profile

Table 4-35: Option 4A Life Cycle Costing

Table 4-35: Option 4A Life Cycle Costing (Pula)							
Reference Year	Water Demand (Mm ₃)	Capital Cost	Electricity - Pumping Cost	Maintenance Cost	NPV at 6% Discount Rate	NPV at 8% Discount Rate	NPV at 10% Discount Rate
0	69.80	1,913,100,000			1,913,100,000	1,913,100,000	1,913,100,000
1	70.66	1,913,100,000			1,913,100,000	1,913,100,000	1,913,100,000
2	71.57	1,913,100,000			1,913,100,000	1,913,100,000	1,913,100,000
3	73.23	1,913,100,000			1,913,100,000	1,913,100,000	1,913,100,000
4	74.19	-	34,889,000	45,169,000	63,413,000	58,845,000	54,680,000
5	74.64	-	34,889,000	45,169,000	59,824,000	54,486,000	49,710,000
6	75.58	-	34,889,000	45,169,000	56,438,000	50,450,000	45,190,000
7	76.56	-	34,889,000	45,169,000	53,243,000	46,713,000	41,082,000
8	77.56	-	34,889,000	45,169,000	50,229,000	43,253,000	37,348,000
9	78.56	-	34,889,000	45,169,000	47,386,000	40,049,000	33,952,000
10	79.58	-	34,889,000	45,169,000	44,704,000	37,082,000	30,866,000
11	80.57	-	34,889,000	45,169,000	42,173,000	34,335,000	28,060,000
12	81.62	-	34,889,000	45,169,000	39,786,000	31,792,000	25,509,000
13	82.68	-	34,889,000	45,169,000	37,534,000	29,437,000	23,190,000
14	83.76	-	34,889,000	45,169,000	35,410,000	27,257,000	21,082,000
15	84.84	-	34,889,000	45,169,000	33,405,000	25,238,000	19,165,000
16	85.93	-	34,889,000	45,169,000	31,514,000	23,368,000	17,423,000
17	87.07	-	34,889,000	45,169,000	29,731,000	21,637,000	15,839,000
18	88.16	-	34,889,000	45,169,000	28,048,000	20,034,000	14,399,000
19	89.31	-	36,779,000	45,169,000	27,085,000	18,988,000	13,399,000
20	90.43	-	36,779,000	45,169,000	25,552,000	17,582,000	12,181,000
21	91.54	-	36,779,000	45,169,000	24,106,000	16,279,000	11,074,000
22	92.66	-	36,779,000	45,169,000	22,741,000	15,074,000	10,067,000
23	93.05	-	36,779,000	45,169,000	21,454,000	13,957,000	9,151,800
24	94.20	-	36,779,000	45,169,000	20,239,000	12,923,000	8,319,800
25	104.50	-	36,779,000	45,169,000	19,094,000	11,966,000	7,563,500
26	105.77	-	36,779,000	45,169,000	18,013,000	11,080,000	6,875,900
27	107.05	-	36,779,000	45,169,000	16,993,000	10,259,000	6,250,800
28	108.35	-	36,779,000	45,169,000	16,032,000	9,498,900	5,682,600
29	109.67	-	36,779,000	45,169,000	15,124,000	8,795,300	5,166,000
30	113.75	-	36,779,000	45,169,000	14,268,000	8,143,800	4,696,300
31	115.13	-	36,779,000	45,169,000	13,460,000	7,540,600	4,269,400
32	116.53	-	36,779,000	45,169,000	12,698,000	6,982,000	3,881,300
33	117.95	-	36,779,000	45,169,000	11,980,000	6,464,800	3,528,400
34	119.38	-	39,908,000	45,169,000	11,733,000	6,214,500	3,330,100
35	122.97	-	39,908,000	45,169,000	11,069,000	5,754,100	3,027,400
36	124.47	-	39,908,000	45,169,000	10,442,000	5,327,900	2,752,200
37	125.98	-	39,908,000	45,169,000	9,851,300	4,933,200	2,502,000
38	127.51	-	39,908,000	45,169,000	9,293,700	4,567,800	2,274,500

Table 4-35: Option 4A Life Cycle Costing (Pula)							
Reference Year	Water Demand (Mm ₃)	Capital Cost	Electricity - Pumping Cost	Maintenance Cost	NPV at 6% Discount Rate	NPV at 8% Discount Rate	NPV at 10% Discount Rate
39	129.07	-	39,908,000	45,169,000	8,767,600	4,229,500	2,067,700
40	132.24	-	39,908,000	45,169,000	8,271,400	3,916,200	1,879,800
41	133.85	-	39,908,000	45,169,000	7,803,200	3,626,100	1,708,900
42	135.48	-	39,908,000	45,169,000	7,361,500	3,357,500	1,553,500
43	137.13	-	39,908,000	45,169,000	6,944,800	3,108,800	1,412,300
44	141.48	-	39,908,000	45,169,000	6,551,700	2,878,500	1,283,900
45	143.20	-	39,908,000	45,169,000	6,180,800	2,665,300	1,167,200
46	144.95	-	39,908,000	45,169,000	5,831,000	2,467,900	1,061,100
47	146.71	-	39,908,000	45,169,000	5,500,900	2,285,000	964,620
48	148.50	-	39,908,000	45,169,000	5,189,600	2,115,800	876,930
49	150.72	-	44,721,000	45,169,000	5,172,800	2,069,900	842,300
50	152.56	-	44,721,000	45,169,000	4,880,000	1,916,600	765,730
51	154.42	-	44,721,000	45,169,000	4,603,700	1,774,600	696,120
52	156.30	-	44,721,000	45,169,000	4,343,200	1,643,100	632,840
53	158.21	-	44,721,000	45,169,000	4,097,300	1,521,400	575,300
54	159.97	-	44,721,000	45,169,000	3,865,400	1,408,700	523,000
55	161.94	-	44,721,000	45,169,000	3,646,600	1,304,400	475,460
56	163.93	-	44,721,000	45,169,000	3,440,200	1,207,800	432,240
57	165.94	-	44,721,000	45,169,000	3,245,500	1,118,300	392,940
58	167.98	-	44,721,000	45,169,000	3,061,800	1,035,500	357,220
59	170.05	-	44,721,000	45,169,000	2,888,400	958,760	324,740
60	172.14	-	44,721,000	45,169,000	2,724,900	887,740	295,220
61	174.26	-	44,721,000	45,169,000	2,570,700	821,980	268,380
62	176.40	-	44,721,000	45,169,000	2,425,200	761,090	243,990
63	178.57	-	44,721,000	45,169,000	2,287,900	704,720	221,800
					8,758,100,000	8,448,500,000	8,256,900,000

4.9 OPTION 4B

Option 4B consists of two pump stations and two break pressure reservoirs on the line. Pump station PS1 is positioned at chainage 8 km at an elevation of 1063.832 m and pump station PS3 is positioned at chainage 228 km at an elevation of 913.484 m. Break pressure reservoir BPT3 is positioned at chainage 22 km at an elevation of 1101.67 m and break pressure reservoir BPT5 is positioned at chainage 228 km at an elevation of 913.484 m. The pipeline follows R2. The MFD illustrating the transfer scheme is provided in

Figure 1-1. The longitudinal profile of the pipeline together with the position of the pump station and all the reservoirs is illustrated in **Figure 4-17**. The hydraulic grade-line for the option is also illustrated in this figure. The hydraulic system components as sized according to the procedure described in Methodology are summarised in

Table 4-36. The hydraulic calculations are provided electronically in Option 4B.excel sheets on the supporting CD.

Table 4-36: Option 4B Hydraulic Components

Option 4B Summary			
Item	Chainage (km)	Value	
Pipeline	0-8	1.9	m - Diameter
Pump Station	8	50	m - Pumping Head
Pipeline	8-22	1.9	m - Diameter
Break Pressure	22	10	m -Elevation
Pipeline	22-158	1.9	m - Diameter
Pipeline	158-228	1.8	m - Diameter
Break Pressure	228	10	m - Elevation
Pump Station	228	260	m - Pumping Head
Pipeline	228-336	2.2	m -Diameter
Pipeline	336-478	1.8	m -Diameter
Pipeline	478-500	1.5	m -Diameter

The capital costs as calculated for the LCCA for Option 4B are provided in **Table 4-37** and the calculated maintenance costs are provided in

Table 4-38. The electricity costs for the option are summarised in **Table 4-39**. The complete life cycle costing calculation is provided in

Table 4-40. The Net Present Value (NPV) for the option was calculated for the three different discount rates analysed by taking the yearly expenditure back to a 2010 present value. The calculated NPVs are compared in greater detail in Option Comparison. Option 4B's LCCA calculations are provided electronically in Option 4BLCCA excel sheets.

Table 4-37: Option 4B Capital costs

Option 4B Capital Costs (Pula)	
Pipe Cost	5,150,000,000.00
Pipe Laying and Joining	1,030,000,000.00
Pipe Trench Excavation & Back Fill	733,500,000.00
Air Valve, Scour Valve & Isolating Cost	322,000,000.00
Pump Station Cost PS 1	28,600,000.00
Pump Station Cost PS 3	96,330,000.00
Reservoir Cost BPT 3	2,600,000.00
Reservoir Cost BPT 5	2,600,000.00

Table 4-38: Option 4B Maintenance Costs

Option 4B Maintenance Costs (Pula)		
Item	Percentage Per Annum	Cost P/year
Civil	0.50%	25,800,000.00
Mechanical & Electrical	4%	17,900,000.00
Total		43,700,000.00

Table 4-39: Option 4B Energy Costs Summary

Pipe Type	Energy Cost Per Year PS 1 (Pula)	Energy Cost Per Year PS 2 (Pula)
New Pipe	6,000,000.00	28,600,000.00
Average Pipe	6,400,000.00	30,120,000.00
Old Pipe	6,900,000.00	32,500,000.00
Biofilm Pipe	7,700,000.00	36,520,000.31

Figure 4-16: Option 4B MFD

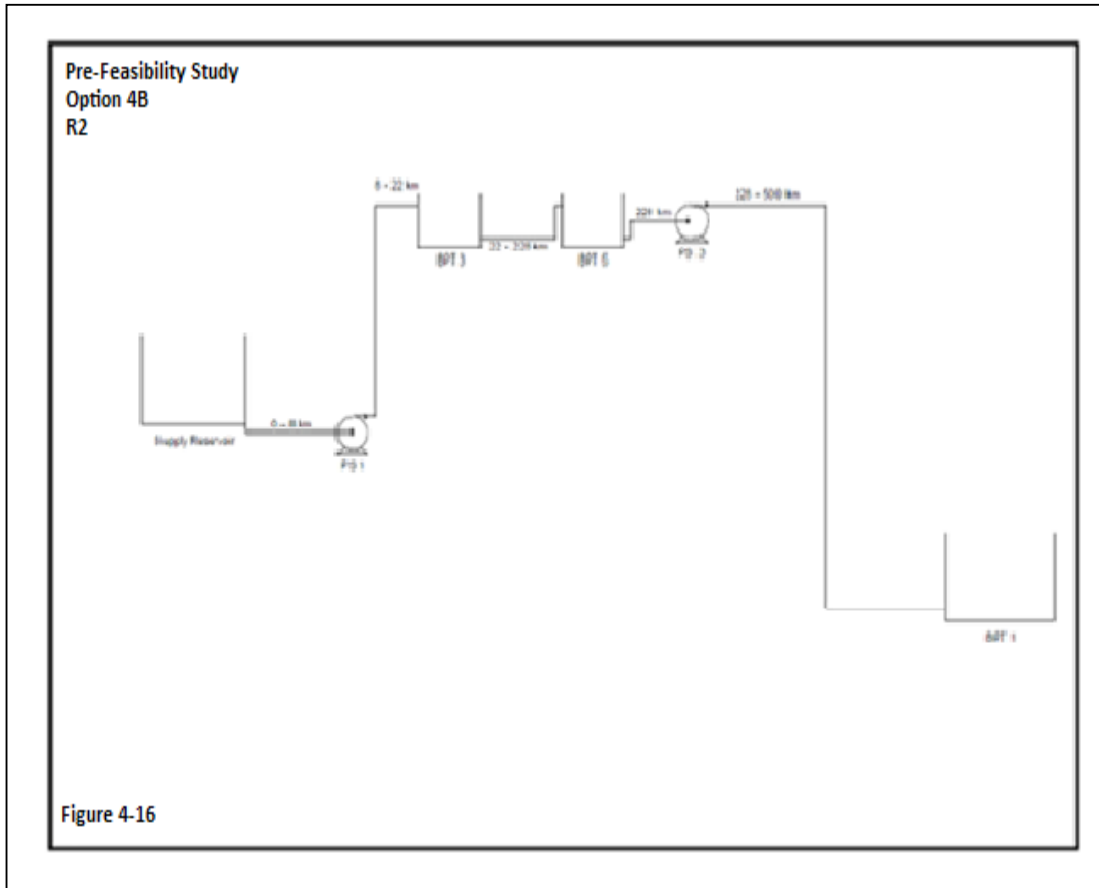

Figure 4-17: Option 4B Longitudinal and Energy Profile

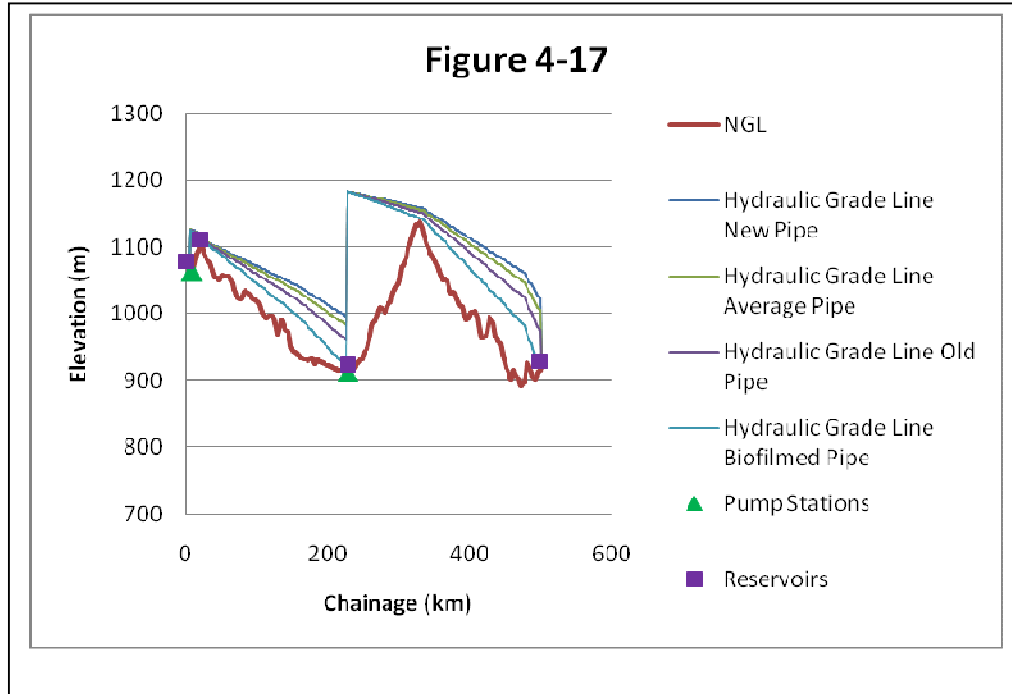

Table 4-40: Option 4B Life Cycle Costing

Table 4-40: Option 4B Life Cycle Costing (Pula)							
Reference Year	Water Demand (Mm ³)	Capital Cost	Electricity - Pumping Cost	Maintenance Cost	NPV at 6% Discount Rate	NPV at 8% Discount Rate	NPV at 10% Discount Rate
0	69.80	1,841,300,000			1,841,300,000	1,841,300,000	1,841,300,000
1	70.66	1,841,300,000			1,841,300,000	1,841,300,000	1,841,300,000
2	71.57	1,841,300,000			1,841,300,000	1,841,300,000	1,841,300,000
3	73.23	1,841,300,000			1,841,300,000	1,841,300,000	1,841,300,000
4	74.19	-	34,549,000	43,644,000	61,936,000	57,474,000	53,407,000
5	74.64	-	34,549,000	43,644,000	58,430,000	53,217,000	48,552,000
6	75.58	-	34,549,000	43,644,000	55,123,000	49,275,000	44,138,000
7	76.56	-	34,549,000	43,644,000	52,003,000	45,625,000	40,125,000
8	77.56	-	34,549,000	43,644,000	49,059,000	42,245,000	36,478,000
9	78.56	-	34,549,000	43,644,000	46,282,000	39,116,000	33,161,000
10	79.58	-	34,549,000	43,644,000	43,663,000	36,218,000	30,147,000
11	80.57	-	34,549,000	43,644,000	41,191,000	33,536,000	27,406,000
12	81.62	-	34,549,000	43,644,000	38,860,000	31,051,000	24,915,000
13	82.68	-	34,549,000	43,644,000	36,660,000	28,751,000	22,650,000
14	83.76	-	34,549,000	43,644,000	34,585,000	26,622,000	20,591,000
15	84.84	-	34,549,000	43,644,000	32,627,000	24,650,000	18,719,000
16	85.93	--	34,549,000	43,644,000	30,780,000	22,824,000	17,017,000

Table 4-40: Option 4B Life Cycle Costing (Pula)							
Reference Year	Water Demand (Mm ₃)	Capital Cost	Electricity - Pumping Cost	Maintenance Cost	NPV at 6% Discount Rate	NPV at 8% Discount Rate	NPV at 10% Discount Rate
17	87.07	-	34,549,000	43,644,000	29,038,000	21,133,000	15,470,000
18	88.16	-	34,549,000	43,644,000	27,394,000	19,568,000	14,064,000
19	89.31	-	36,440,000	43,644,000	26,469,000	18,556,000	13,094,000
20	90.43	-	36,440,000	43,644,000	24,970,000	17,182,000	11,904,000
21	91.54	-	36,440,000	43,644,000	23,557,000	15,909,000	10,822,000
22	92.66	-	36,440,000	43,644,000	22,224,000	14,731,000	9,837,900
23	93.05	-	36,440,000	43,644,000	20,966,000	13,639,000	8,943,600
24	94.20	-	36,440,000	43,644,000	19,779,000	12,629,000	8,130,500
25	104.50	-	36,440,000	43,644,000	18,659,000	11,694,000	7,391,400
26	105.77	-	36,440,000	43,644,000	17,603,000	10,827,000	6,719,400
27	107.05	-	36,440,000	43,644,000	16,607,000	10,025,000	6,108,600
28	108.35	-	36,440,000	43,644,000	15,667,000	9,282,800	5,553,300
29	109.67	-	36,440,000	43,644,000	14,780,000	8,595,200	5,048,400
30	113.75	-	36,440,000	43,644,000	13,943,000	7,958,500	4,589,500
31	115.13	-	36,440,000	43,644,000	13,154,000	7,369,000	4,172,200
32	116.53	-	36,440,000	43,644,000	12,410,000	6,823,100	3,792,900
33	117.95	-	36,440,000	43,644,000	11,707,000	6,317,700	3,448,100
34	119.38	-	39,362,000	43,644,000	11,447,000	6,063,200	3,249,100
35	122.97	-	39,362,000	43,644,000	10,799,000	5,614,100	2,953,700
36	124.47	-	39,362,000	43,644,000	10,188,000	5,198,200	2,685,200
37	125.98	-	39,362,000	43,644,000	9,611,500	4,813,200	2,441,100
38	127.51	-	39,362,000	43,644,000	9,067,500	4,456,600	2,219,100
39	129.07	-	39,362,000	43,644,000	8,554,200	4,126,500	2,017,400
40	132.24	-	39,362,000	43,644,000	8,070,000	3,820,800	1,834,000
41	133.85	-	39,362,000	43,644,000	7,613,200	3,537,800	1,667,300
42	135.48	-	39,362,000	43,644,000	7,182,300	3,275,800	1,515,700
43	137.13	-	39,362,000	43,644,000	6,775,700	3,033,100	1,377,900
44	141.48	-	39,362,000	43,644,000	6,392,200	2,808,400	1,252,700
45	143.20	-	39,362,000	43,644,000	6,030,400	2,600,400	1,138,800
46	144.95	-	39,362,000	43,644,000	5,689,000	2,407,800	1,035,200
47	146.71	-	39,362,000	43,644,000	5,367,000	2,229,400	941,140
48	148.50	-	39,362,000	43,644,000	5,063,200	2,064,300	855,580
49	150.72	-	44,175,000	43,644,000	5,053,600	2,022,200	822,900
50	152.56	-	44,175,000	43,644,000	4,767,500	1,872,400	748,090
51	154.42	-	44,175,000	43,644,000	4,497,700	1,733,700	680,080
52	156.30	-	44,175,000	43,644,000	4,243,100	1,605,300	618,250
53	158.21	-	44,175,000	43,644,000	4,002,900	1,486,400	562,050
54	159.97	-	44,175,000	43,644,000	3,776,300	1,376,300	510,950
55	161.94	-	44,175,000	43,644,000	3,562,600	1,274,300	464,500
56	163.93	-	44,175,000	43,644,000	3,360,900	1,179,900	422,280
57	165.94	-	44,175,000	43,644,000	3,170,700	1,092,500	383,890

Reference Year	Water Demand (Mm ₃)	Capital Cost	Electricity - Pumping Cost	Maintenance Cost	NPV at 6% Discount Rate	NPV at 8% Discount Rate	NPV at 10% Discount Rate
58	167.98	-	44,175,000	43,644,000	2,991,200	1,011,600	348,990
59	170.05	-	44,175,000	43,644,000	2,821,900	936,670	317,260
60	172.14	-	44,175,000	43,644,000	2,662,200	867,280	288,420
61	174.26	-	44,175,000	43,644,000	2,511,500	803,040	262,200
62	176.40	-	44,175,000	43,644,000	2,369,300	743,560	238,360
63	178.57	-	44,175,000	43,644,000	2,235,200	688,480	216,690
					8,445,100,000	8,142,700,000	7,955,600,000

4.10 OPTION 5A

Option 5A consists of two pump stations and three break pressure reservoirs on the line. Pump station PS1 is positioned at chainage 8 km at an elevation of 1063.832 m and pump station PS3 is positioned at chainage 228 km at an elevation of 913.484 m and pump. Break pressure reservoir BPT3 is positioned at chainage 22 km at an elevation of 1101.67 m, break pressure reservoir BPT5 is positioned at chainage 228 km at an elevation of 913.484 m and break pressure reservoir BPT2 is positioned at chainage 330 km at an elevation of 1136.405 m. The pipeline follows R1. The MFD illustrating the transfer scheme is provided in **Figure 4-18**. The longitudinal profile of the pipeline together with the position of the pump station and all the reservoirs is illustrated in **Figure 4-19**. The hydraulic grade-line for the option is also illustrated in this figure. The hydraulic system components as sized according to the procedure described in Methodology are summarised in **Table 4-41**. The hydraulic calculations are provided electronically in Option 5A excel sheets on the supporting CD.

Table 4-41: Option 5A Hydraulic Components

Item	Chainage (km)	Value	
Pipeline	0-8	1.9	m - Diameter
Pump Station	8	50	m - Pumping Head
Pipeline	8-22	1.9	m - Diameter
Break Pressure	22	10	m -Elevation
Pipeline	22-156	1.9	m - Diameter
Pipeline	156-226	1.8	m - Diameter
Pipeline	226-228	2.2	m - Diameter
Break Pressure	228	10	m - Elevation
Pump Station	228	50	m - Pumping Head
Pipeline	228-328	2.2	m -Diameter
Pipeline	328-330	2	m -Diameter
Break Pressure	330	10	m -Elevation
Pipeline	330-508	1.8	m -Diameter

Option 5A Summary			
Item	Chainage (km)	Value	
Pipeline	508-520	1.5	m - Elevation

The capital costs as calculated for the LCCA for Option 5A are provided in **Table 4-42** and the calculated maintenance costs are provided in **Table 4-43**. The electricity costs for the option are summarised in **Table 4-44**. The complete life cycle costing calculation is provided in **Table 4-45**. The Net Present Value (NPV) for the option was calculated for the three different discount rates analysed by taking the yearly expenditure back to a 2010 present value. The calculated NPVs are compared in greater detail in Option Comparison. Option 5A's LCCA calculations are provided electronically in Option 5A LCCA excel sheets.

Table 4-42: Option 5A Capital Costs

Option 5A Capital Costs (Pula)	
Pipe Cost	5,405,400,000.00
Pipe Laying and Joining	1,081,100,000.00
Pipe Trench Excavation & Back Fill	761,200,000.00
Air Valve, Scour Valve & Isolating Cost	333,800,000.00
Pump Station Cost PS 1	28,600,000.00
Pump Station Cost PS 3	96,300,000.00
Reservoir Cost BPT 3	2,600,000.00
Reservoir Cost BPT 5	2,600,000.00
Reservoir Cost BPT 2	2,600,000.00
Total	7,714,200,000.00

Table 4-43: Option 5A Maintenance Costs

Option 5A Maintenance Costs (Pula)		
Item	Percentage Per Annum	Cost P/year
Civil	0.50%	27,100,000.00
Mechanical & Electrical	4%	18,300,000.00
Total		45,400,000.00

Table 4-44: Option 5A Energy Costs Summary

Pipe Type	Energy Cost Per Year PS 1 (Pula)	Energy Cost Per Year PS 2 (Pula)
New Pipe	6,158,431.58	28,730,458.01
Average Pipe	6,491,302.85	30,288,116.47
Old Pipe	7,023,896.89	32,884,213.91
Biofilm Pipe	7,856,075.06	36,864,896.64

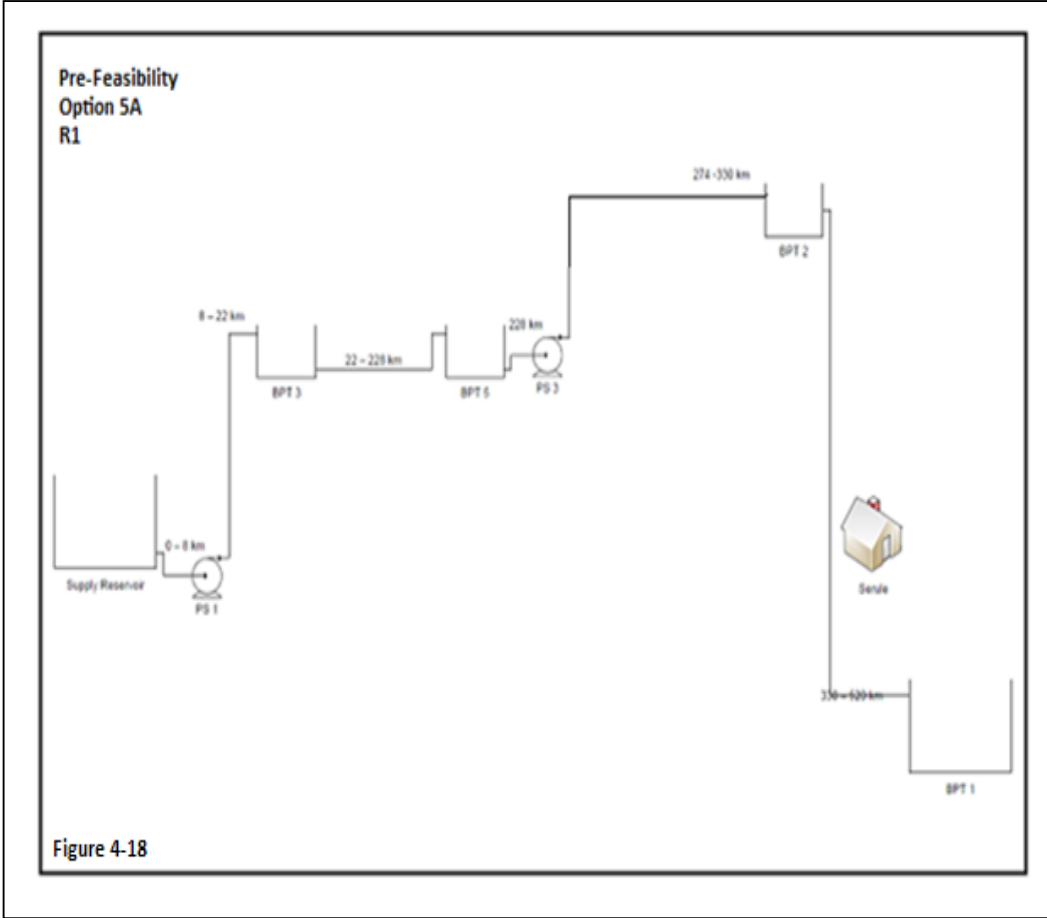

Figure 4-18: Option 5A MFD

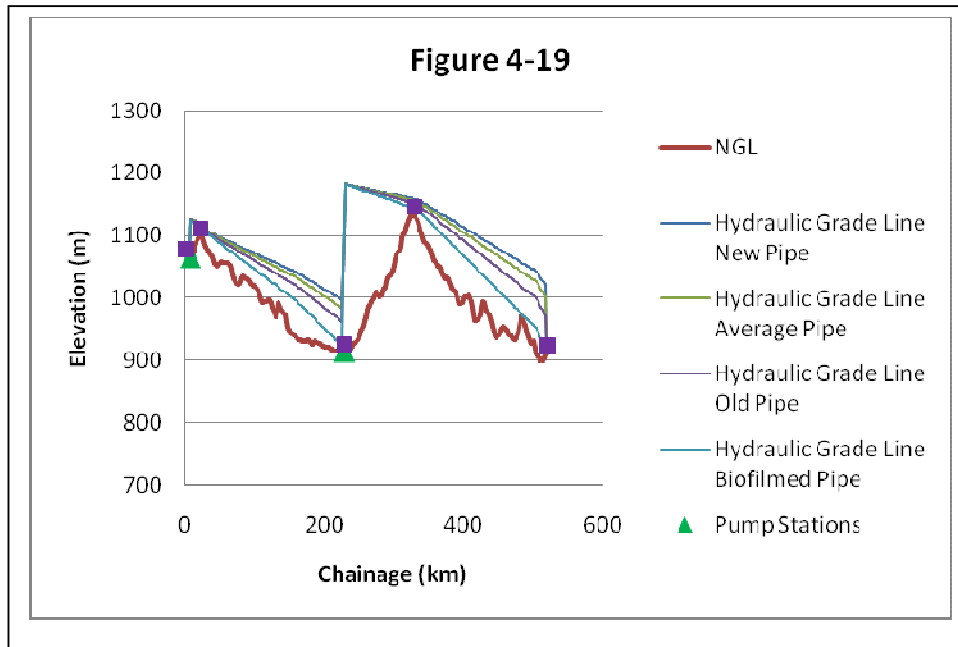

Figure 4-19: Option 5A Longitudinal and Energy Profile

Table 4-45: Option 5A Life Cycle Costing

Table 4-45: Option 5A Life Cycle Costing (Pula)							
Reference Year	Water Demand (Mm ₃)	Capital Cost	Electricity - Pumping Cost	Maintenance Cost	NPV at 6% Discount Rate	NPV at 8% Discount Rate	NPV at 10% Discount Rate
0	69.80	1,928,500,000			1,928,500,000	1,928,500,000	1,928,500,000
1	70.66	1,928,500,000			1,928,500,000	1,928,500,000	1,928,500,000
2	71.57	1,928,500,000			1,928,500,000	1,928,500,000	1,928,500,000
3	73.23	1,928,500,000			1,928,500,000	1,928,500,000	1,928,500,000
4	74.19	-	34,889,000	45,413,000	63,606,000	59,024,000	54,847,000
5	74.64	-	34,889,000	45,413,000	60,006,000	54,652,000	49,861,000
6	75.58	-	34,889,000	45,413,000	56,609,000	50,604,000	45,328,000
7	76.56	-	34,889,000	45,413,000	53,405,000	46,855,000	41,207,000
8	77.56	-	34,889,000	45,413,000	50,382,000	43,384,000	37,461,000
9	78.56	-	34,889,000	45,413,000	47,530,000	40,171,000	34,056,000
10	79.58	-	34,889,000	45,413,000	44,840,000	37,195,000	30,960,000
11	80.57	-	34,889,000	45,413,000	42,302,000	34,440,000	28,145,000
12	81.62	-	34,889,000	45,413,000	39,907,000	31,889,000	25,587,000
13	82.68	-	34,889,000	45,413,000	37,648,000	29,527,000	23,260,000
14	83.76	-	34,889,000	45,413,000	35,517,000	27,340,000	21,146,000
15	84.84	-	34,889,000	45,413,000	33,507,000	25,314,000	19,224,000
16	85.93	-	34,889,000	45,413,000	31,610,000	23,439,000	17,476,000
17	87.07	-	34,889,000	45,413,000	29,821,000	21,703,000	15,887,000

Table 4-45: Option 5A Life Cycle Costing (Pula)							
Reference Year	Water Demand (Mm ₃)	Capital Cost	Electricity - Pumping Cost	Maintenance Cost	NPV at 6% Discount Rate	NPV at 8% Discount Rate	NPV at 10% Discount Rate
18	88.16	-	34,889,000	45,413,000	28,133,000	20,095,000	14,443,000
19	89.31	-	36,779,000	45,413,000	27,166,000	19,045,000	13,439,000
20	90.43	-	36,779,000	45,413,000	25,628,000	17,634,000	12,217,000
21	91.54	-	36,779,000	45,413,000	24,177,000	16,328,000	11,107,000
22	92.66	-	36,779,000	45,413,000	22,809,000	15,118,000	10,097,000
23	93.05	-	36,779,000	45,413,000	21,518,000	13,999,000	9,179,100
24	94.20	-	36,779,000	45,413,000	20,300,000	12,962,000	8,344,600
25	104.50	-	36,779,000	45,413,000	19,151,000	12,002,000	7,586,000
26	105.77	-	36,779,000	45,413,000	18,067,000	11,113,000	6,896,400
27	107.05	-	36,779,000	45,413,000	17,044,000	10,289,000	6,269,400
28	108.35	-	36,779,000	45,413,000	16,079,000	9,527,200	5,699,500
29	109.67	-	36,779,000	45,413,000	15,169,000	8,821,500	5,181,300
30	113.75	-	36,779,000	45,413,000	14,310,000	8,168,000	4,710,300
31	115.13	-	36,779,000	45,413,000	13,500,000	7,563,000	4,282,100
32	116.53	-	36,779,000	45,413,000	12,736,000	7,002,800	3,892,800
33	117.95	-	36,779,000	45,413,000	12,015,000	6,484,000	3,538,900
34	119.38	-	39,908,000	45,413,000	11,767,000	6,232,300	3,339,700
35	122.97	-	39,908,000	45,413,000	11,101,000	5,770,600	3,036,100
36	124.47	-	39,908,000	45,413,000	10,472,000	5,343,200	2,760,100
37	125.98	-	39,908,000	45,413,000	9,879,600	4,947,400	2,509,100
38	127.51	-	39,908,000	45,413,000	9,320,300	4,580,900	2,281,000
39	129.07	-	39,908,000	45,413,000	8,792,800	4,241,600	2,073,700
40	132.24	-	39,908,000	45,413,000	8,295,100	3,927,400	1,885,200
41	133.85	-	39,908,000	45,413,000	7,825,500	3,636,500	1,713,800
42	135.48	-	39,908,000	45,413,000	7,382,600	3,367,100	1,558,000
43	137.13	-	39,908,000	45,413,000	6,964,700	3,117,700	1,416,300
44	141.48	-	39,908,000	45,413,000	6,570,500	2,886,800	1,287,600
45	143.20	-	39,908,000	45,413,000	6,198,600	2,672,900	1,170,500
46	144.95	-	39,908,000	45,413,000	5,847,700	2,474,900	1,064,100
47	146.71	-	39,908,000	45,413,000	5,516,700	2,291,600	967,380
48	148.50	-	39,908,000	45,413,000	5,204,400	2,121,800	879,440
49	150.72	-	44,721,000	45,413,000	5,186,800	2,075,500	844,590
50	152.56	-	44,721,000	45,413,000	4,893,200	1,921,800	767,810
51	154.42	-	44,721,000	45,413,000	4,616,200	1,779,400	698,010
52	156.30	-	44,721,000	45,413,000	4,354,900	1,647,600	634,550
53	158.21	-	44,721,000	45,413,000	4,108,400	1,525,600	576,870
54	159.97	-	44,721,000	45,413,000	3,875,900	1,412,600	524,420
55	161.94	-	44,721,000	45,413,000	3,656,500	1,307,900	476,750
56	163.93	-	44,721,000	45,413,000	3,449,500	1,211,000	433,410
57	165.94	-	44,721,000	45,413,000	3,254,300	1,121,300	394,010
58	167.98	-	44,721,000	45,413,000	3,070,100	1,038,300	358,190

Reference Year	Water Demand (Mm ₃)	Capital Cost	Electricity - Pumping Cost	Maintenance Cost	NPV at 6% Discount Rate	NPV at 8% Discount Rate	NPV at 10% Discount Rate
59	170.05	-	44,721,000	45,413,000	2,896,300	961,360	325,630
60	172.14	-	44,721,000	45,413,000	2,732,300	890,150	296,020
61	174.26	-	44,721,000	45,413,000	2,577,700	824,210	269,110
62	176.40	-	44,721,000	45,413,000	2,431,800	763,160	244,650
63	178.57	-	44,721,000	45,413,000	2,294,100	706,630	222,410
					8,823,100,000	8,512,500,000	8,320,400,000

4.11 OPTION 5B

Option 5B consists of two pump stations and three break pressure reservoirs on the line. Pump station PS1 is positioned at chainage 8 km at an elevation of 1063.832 m and pump station PS3 is positioned at chainage 228 km at an elevation of 913.484 m and pump. Break pressure reservoir BPT3 is positioned at chainage 22 km at an elevation of 1101.67 m, break pressure reservoir BPT5 is positioned at chainage 228 km at an elevation of 913.484 m and break pressure reservoir BPT2 is positioned at chainage 330 km at an elevation of 1136.405 m. The pipeline follows R2. The MFD illustrating the transfer scheme is provided in **Figure 4-20**. The longitudinal profile of the pipeline together with the position of the pump station and all the reservoirs is illustrated in **Figure 4-21**. The hydraulic grade-line for the option is also illustrated in this figure. The hydraulic system components as sized according to the procedure described in methodology are summarised in **Table 4-46**. The hydraulic calculations are provided electronically in Option 5B excel sheets on the supporting CD.

Table 4-46: Option 5B Hydraulic Components

Item	Chainage (km)	Value	
Pipeline	0-8	1.9	m - Diameter
Pump Station	8	50	m - Pumping Head
Pipeline	8-22	1.9	m - Diameter
Break Pressure	22	10	m -Elevation
Pipeline	22-156	1.9	m - Diameter
Pipeline	156-226	1.8	m - Diameter
Pipeline	226-228	2.2	m - Diameter
Break Pressure	228	10	m - Elevation
Pump Station	228	50	m - Pumping Head
Pipeline	228-328	2.2	m -Diameter
Pipeline	328-330	2	m -Diameter
Break Pressure	330	10	m -Elevation
Pipeline	330-508	1.8	m -Diameter
Pipeline	508-500	1.5	m - Elevation

The capital costs as calculated for the LCCA for Option 10 are provided in **Table 4-47** and the calculated maintenance costs are provided in **Table 4-48**. The electricity costs for the option are summarised in **Table 4-49**. The complete life cycle costing calculation is provided in **Table 4-50**. The Net Present Value (NPV) for the option was calculated for the three different discount rates analysed by taking the yearly expenditure back to a 2010 present value. The calculated NPVs are compared in greater detail in Option Comparison. Option 5B's LCCA calculations are provided electronically in Option 5B LCCA excel sheets.

Table 4-47: Option 5B Capital Costs

Option 5B Capital Costs (Pula)	
Pipe Cost	5,757,500,000.00
Pipe Laying and Joining	1,151,500,000.00
Pipe Trench Excavation & Back Fill	805,370,452.57
Air Valve, Scour Valve & Isolating Cost	353,140,000.00
Pump Station Cost PS 1	31,430,340.97
Pump Station Cost PS 3	105,960,972.01
Reservoir Cost BPT 3	2,822,169.60
Reservoir Cost BPT 5	2,822,169.60
Reservoir Cost BPT 2	2,822,169.60
Total	8,213,368,274.35

Table 4-48: Option 5B Maintenance Costs

Option 5B Maintenance Costs (Pula)		
Item	Percentage Per Annum	Cost P/year
Civil	0.50%	26,208,874.43
Mechanical & Electrical	4%	17,837,502.29
Total		44,046,376.72

Table 4-49: Option 5B Energy Costs Summary

Pipe Type	Energy Cost Per Year PS 1 (Pula)	Energy Cost Per Year PS 2 (Pula)
New Pipe	6,158,431.58	28,730,458.01
Average Pipe	6,491,302.85	30,288,116.47
Old Pipe	7,023,896.89	32,884,213.91
Biofilm Pipe	7,856,075.06	36,864,896.64

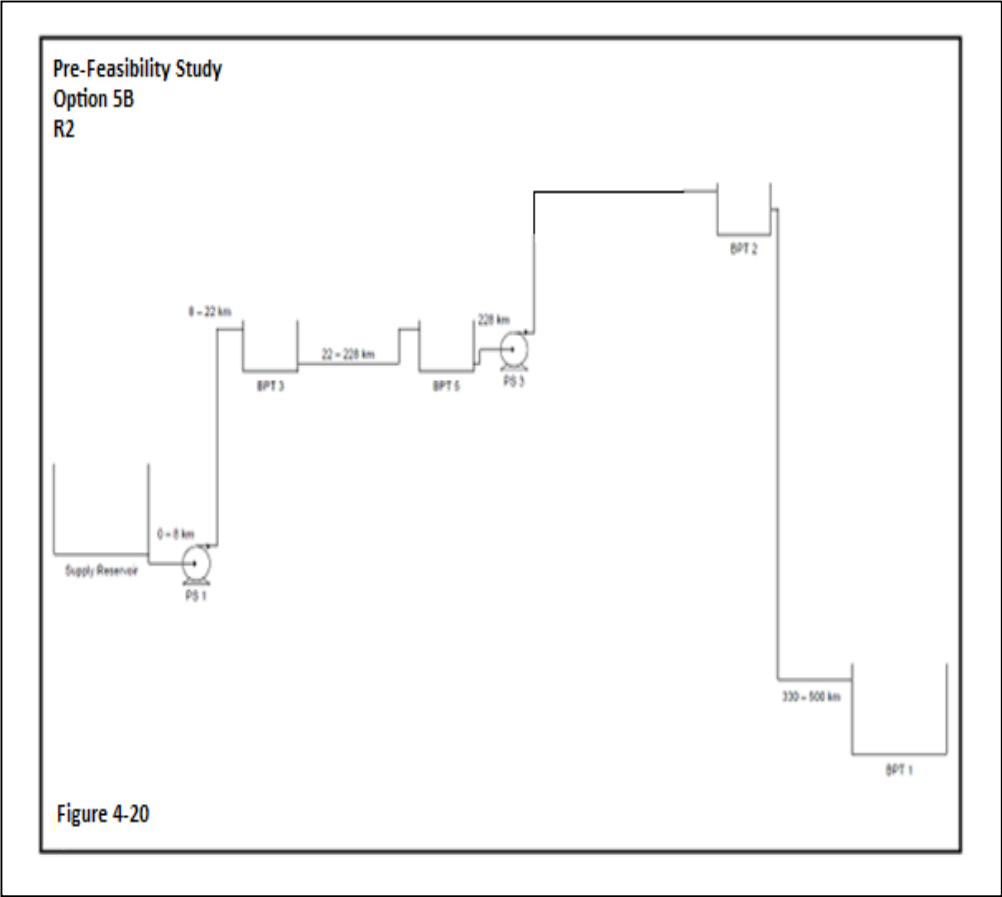

Figure 4-20: Option 5B MFD

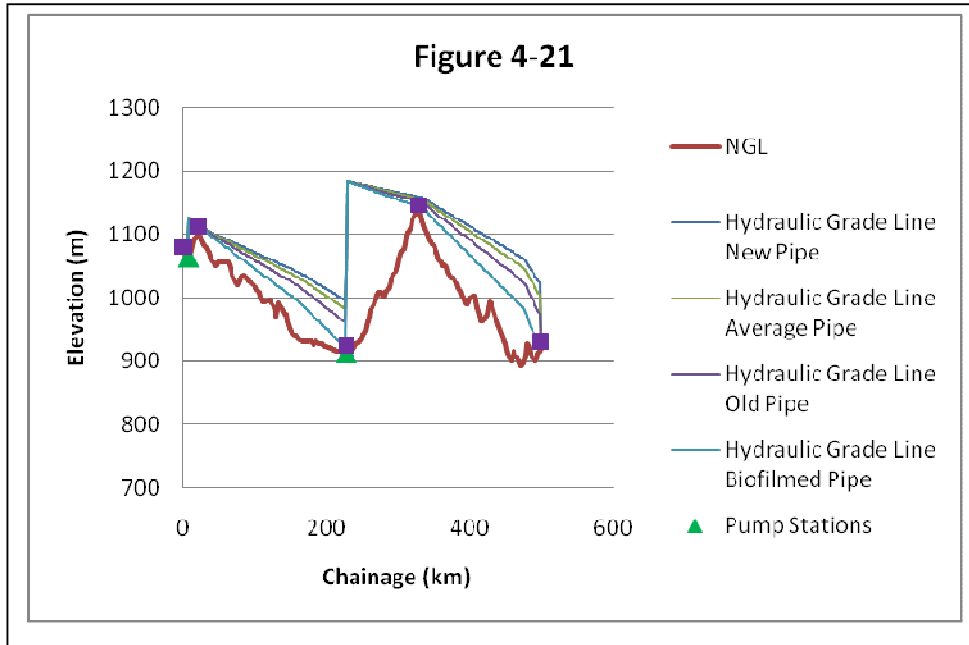

Figure 4-21: Option 5B Longitudinal and Energy Profile

Table 4-50: Option 5B Life Cycle Costing

Table 4-50: Option 5B Life Cycle Costing (Pula)							
Reference Year	Water Demand (Mm ₃)	Capital Cost	Electricity - Pumping Cost	Maintenance Cost	NPV at 6% Discount Rate	NPV at 8% Discount Rate	NPV at 10% Discount Rate
0	69.80	1,866,700,000			1,866,700,000	1,866,700,000	1,866,700,000
1	70.66	1,866,700,000			1,866,700,000	1,866,700,000	1,866,700,000
2	71.57	1,866,700,000			1,866,700,000	1,866,700,000	1,866,700,000
3	73.23	1,866,700,000			1,866,700,000	1,866,700,000	1,866,700,000
4	74.19	-	34,889,000	44,046,000	62,524,000	58,020,000	53,914,000
5	74.64	-	34,889,000	44,046,000	58,985,000	53,722,000	49,013,000
6	75.58	-	34,889,000	44,046,000	55,646,000	49,743,000	44,557,000
7	76.56	-	34,889,000	44,046,000	52,496,000	46,058,000	40,506,000
8	77.56	-	34,889,000	44,046,000	49,525,000	42,646,000	36,824,000
9	78.56	-	34,889,000	44,046,000	46,722,000	39,487,000	33,476,000
10	79.58	-	34,889,000	44,046,000	44,077,000	36,562,000	30,433,000
11	80.57	-	34,889,000	44,046,000	41,582,000	33,854,000	27,666,000
12	81.62	-	34,889,000	44,046,000	39,228,000	31,346,000	25,151,000
13	82.68	-	34,889,000	44,046,000	37,008,000	29,024,000	22,865,000
14	83.76	-	34,889,000	44,046,000	34,913,000	26,874,000	20,786,000
15	84.84	-	34,889,000	44,046,000	32,937,000	24,884,000	18,896,000
16	85.93	-	34,889,000	44,046,000	31,073,000	23,040,000	17,179,000

Table 4-50: Option 5B Life Cycle Costing (Pula)							
Reference Year	Water Demand (Mm ₃)	Capital Cost	Electricity - Pumping Cost	Maintenance Cost	NPV at 6% Discount Rate	NPV at 8% Discount Rate	NPV at 10% Discount Rate
17	87.07	-	34,889,000	44,046,000	29,314,000	21,334,000	15,617,000
18	88.16	-	34,889,000	44,046,000	27,654,000	19,753,000	14,197,000
19	89.31	-	36,779,000	44,046,000	26,714,000	18,728,000	13,216,000
20	90.43	-	36,779,000	44,046,000	25,202,000	17,341,000	12,014,000
21	91.54	-	36,779,000	44,046,000	23,775,000	16,057,000	10,922,000
22	92.66	-	36,779,000	44,046,000	22,430,000	14,867,000	9,929,100
23	93.05	-	36,779,000	44,046,000	21,160,000	13,766,000	9,026,500
24	94.20	-	36,779,000	44,046,000	19,962,000	12,746,000	8,205,900
25	104.50	-	36,779,000	44,046,000	18,832,000	11,802,000	7,459,900
26	105.77	-	36,779,000	44,046,000	17,766,000	10,928,000	6,781,700
27	107.05	-	36,779,000	44,046,000	16,761,000	10,118,000	6,165,200
28	108.35	-	36,779,000	44,046,000	15,812,000	9,368,800	5,604,700
29	109.67	-	36,779,000	44,046,000	14,917,000	8,674,800	5,095,200
30	113.75	-	36,779,000	44,046,000	14,073,000	8,032,300	4,632,000
31	115.13	-	36,779,000	44,046,000	13,276,000	7,437,300	4,210,900
32	116.53	-	36,779,000	44,046,000	12,525,000	6,886,400	3,828,100
33	117.95	-	36,779,000	44,046,000	11,816,000	6,376,300	3,480,100
34	119.38	-	39,908,000	44,046,000	11,578,000	6,132,500	3,286,200
35	122.97	-	39,908,000	44,046,000	10,923,000	5,678,200	2,987,400
36	124.47	-	39,908,000	44,046,000	10,305,000	5,257,600	2,715,900
37	125.98	-	39,908,000	44,046,000	9,721,400	4,868,200	2,469,000
38	127.51	-	39,908,000	44,046,000	9,171,100	4,507,600	2,244,500
39	129.07	-	39,908,000	44,046,000	8,652,000	4,173,700	2,040,500
40	132.24	-	39,908,000	44,046,000	8,162,200	3,864,500	1,855,000
41	133.85	-	39,908,000	44,046,000	7,700,200	3,578,200	1,686,300
42	135.48	-	39,908,000	44,046,000	7,264,400	3,313,200	1,533,000
43	137.13	-	39,908,000	44,046,000	6,853,200	3,067,800	1,393,700
44	141.48	-	39,908,000	44,046,000	6,465,300	2,840,500	1,267,000
45	143.20	-	39,908,000	44,046,000	6,099,300	2,630,100	1,151,800
46	144.95	-	39,908,000	44,046,000	5,754,100	2,435,300	1,047,100
47	146.71	-	39,908,000	44,046,000	5,428,400	2,254,900	951,890
48	148.50	-	39,908,000	44,046,000	5,121,100	2,087,900	865,360
49	150.72	-	44,721,000	44,046,000	5,108,200	2,044,000	831,790
50	152.56	-	44,721,000	44,046,000	4,819,000	1,892,600	756,170
51	154.42	-	44,721,000	44,046,000	4,546,300	1,752,400	687,430
52	156.30	-	44,721,000	44,046,000	4,288,900	1,622,600	624,930
53	158.21	-	44,721,000	44,046,000	4,046,200	1,502,400	568,120
54	159.97	-	44,721,000	44,046,000	3,817,100	1,391,100	516,470
55	161.94	-	44,721,000	44,046,000	3,601,100	1,288,100	469,520
56	163.93	-	44,721,000	44,046,000	3,397,200	1,192,700	426,840
57	165.94	-	44,721,000	44,046,000	3,204,900	1,104,300	388,030

Reference Year	Water Demand (Mm ₃)	Capital Cost	Electricity - Pumping Cost	Maintenance Cost	NPV at 6% Discount Rate	NPV at 8% Discount Rate	NPV at 10% Discount Rate
58	167.98	-	44,721,000	44,046,000	3,023,500	1,022,500	352,760
59	170.05	-	44,721,000	44,046,000	2,852,400	946,790	320,690
60	172.14	-	44,721,000	44,046,000	2,690,900	876,650	291,540
61	174.26	-	44,721,000	44,046,000	2,538,600	811,720	265,030
62	176.40	-	44,721,000	44,046,000	2,394,900	751,590	240,940
63	178.57	-	44,721,000	44,046,000	2,259,400	695,920	219,040
					8,557,200,000	8,251,700,000	8,062,800,000

4.12 OPTION 6A

Option 6A consists of three pump stations and four break pressure reservoirs on the line. Pump station PS1 is positioned at chainage 8 km at an elevation of 1063.832 m, pump station PS3 is positioned at chainage 228 km at an elevation of 913.484 m and pump station PS2 is positioned at chainage 274 km at an elevation of 1008.819 m. Break pressure reservoir BPT3 is positioned at chainage 22 km at an elevation of 1101.67 m, break pressure reservoir BPT5 is positioned at chainage 228 km at an elevation of 913.484 m, break pressure reservoir BPT4 is positioned at chainage 274 km at an elevation of 1008.819 m and break pressure reservoir BPT2 is positioned at chainage 330 km at an elevation of 1136.405 m. The pipeline follows R1. The MFD illustrating the transfer scheme is provided in **Figure 4-22**. The longitudinal profile of the pipeline together with the position of the pump station and all the reservoirs is illustrated in **Figure 4-26**. The hydraulic grade-line for the option is also illustrated in this figure. The hydraulic system components as sized according to the procedure described in Methodology are summarised in **Table 4-51**. The hydraulic calculations are provided electronically in Option 6A.excel sheets on the supporting CD.

Table 4-51: Option 6A Hydraulic Components

Option 6A Summary			
Item	Chainage (km)	Value	
Pipeline	0-8	1.9	m - Diameter
Pump Station	8	50	m - Pumping Head
Pipeline	8-22	1.9	m - Diameter
Break Pressure	22	10	m -Elevation
Pipeline	22-164	1.9	m - Diameter
Pipeline	164-226	1.8	m - Diameter
Pipeline	226-228	2	m – Diameter
Break Pressure	228	10	m – Elevation
Pump Station	228	120	m - Pumping Head
Pipeline	228-274	2	m –Diameter
Pump Station	274	160	m - Pumping Head
Pipeline	274-330	2	m –Diameter
Break Pressure	330	10	m – Elevation
Pipeline	330-508	1.8	m –Diameter
Pipeline	508-520	1.5	m –Diameter

The capital costs as calculated for the LCCA for Option 6A are provided in **Table 4-52** and the calculated maintenance costs are provided in **Table 4-53**. The electricity costs for the option are summarised in **Table 4-54**. The complete life cycle costing calculation is provided in **Table 4-55**. The Net Present Value (NPV) for the option was calculated for the three different discount rates analysed by taking the yearly expenditure back to a 2010 present value. The calculated NPVs are compared in greater detail in Option Comparison. Option 6A's LCCA calculations are provided electronically in Option 6A LCCA excel sheets.

Table 4-52: Option 6A Capital Costs

Option 6A Capital Costs (Pula)	
Pipe Cost	5,059,700,000.00
Pipe Laying and Joining	1,011,900,000.00
Pipe Trench Excavation & Back Fill	743,800,000.00
Air Valve, Scour Valve & Isolating Cost	325,600,000.00
Pump Station Cost PS 1	28,600,000.00
Pump Station Cost PS 3	53,600,000.00
Pump Station Cost PS 3	65,200,000.00
Reservoir Cost BPT 3	2,600,000.00
Reservoir Cost BPT 5	2,600,000.00
Reservoir Cost BPT 5	2,600,000.00
Reservoir Cost BPT 5	2,600,000.00
Total	7,296,200,000.00

Table 4-53: Option 6A Maintenance Costs

Option 6A Maintenance Costs (Pula)		
Item	Percentage Per Annum	Cost P/year
Civil	0.50%	25,400,000.00
Mechanical & Electrical	4%	16,400,000.00
Total		41,800,000.00

Table 4-54: Option 6A Energy Costs Summary

Pipe Type	Energy Cost Per Year PS 1 (Pula)	Energy Cost Per Year PS 3 (Pula)	Energy Cost Per Year PS 2 (Pula)
New Pipe	12,940,506.05	16,827,140.57	16,827,140.57
Average Pipe	13,659,405.66	17,785,630.74	17,785,630.74
Old Pipe	14,697,816.21	19,170,116.55	19,170,116.55
Biofilm Pipe	16,455,126.37	21,513,092.53	21,513,092.53

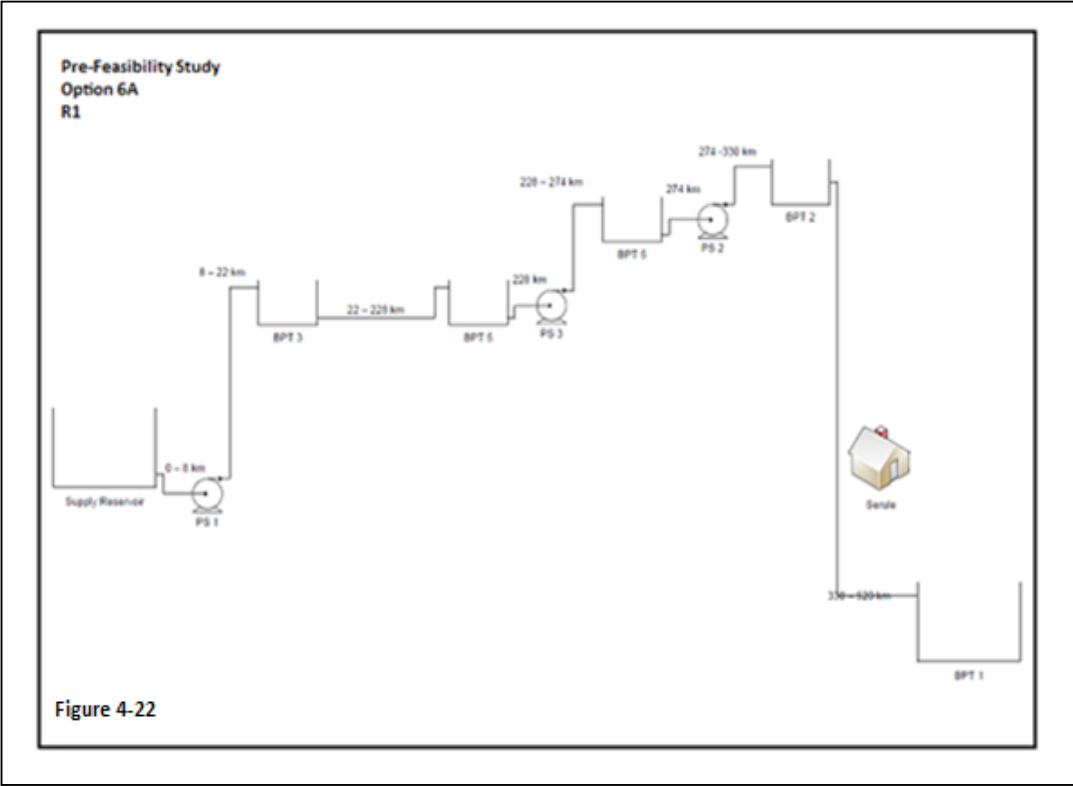

Figure 4-22: Option 6A MFD

Figure 4-23: Option 6A Longitudinal and Energy Profile

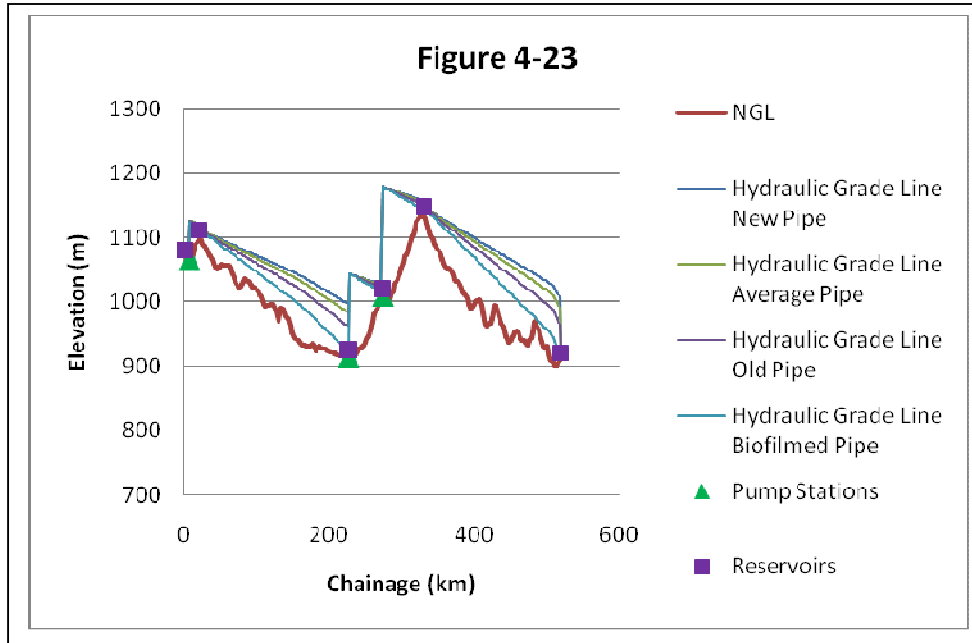

Table 4-55: Option 6A Life Cycle Costing

Table 4-55: Option 6A Life Cycle Costing (Pula)							
Reference Year	Water Demand (Mm ₃)	Capital Cost	Electricity - Pumping Cost	Maintenance Cost	NPV at 6% Discount Rate	NPV at 8% Discount Rate	NPV at 10% Discount Rate
0	69.80	1,824,700,000			1,824,700,000	1,824,700,000	1,824,700,000
1	70.66	1,824,700,000			1,824,700,000	1,824,700,000	1,824,700,000
2	71.57	1,824,700,000			1,824,700,000	1,824,700,000	1,824,700,000
3	73.23	1,824,700,000			1,824,700,000	1,824,700,000	1,824,700,000
4	74.19	-	35,926,000	41,632,000	61,433,000	57,008,000	52,973,000
5	74.64	-	35,926,000	41,632,000	57,956,000	52,785,000	48,158,000
6	75.58	-	35,926,000	41,632,000	54,676,000	48,875,000	43,780,000
7	76.56	-	35,926,000	41,632,000	51,581,000	45,255,000	39,800,000
8	77.56	-	35,926,000	41,632,000	48,661,000	41,902,000	36,182,000
9	78.56	-	35,926,000	41,632,000	45,907,000	38,798,000	32,892,000
10	79.58	-	35,926,000	41,632,000	43,308,000	35,925,000	29,902,000
11	80.57	-	35,926,000	41,632,000	40,857,000	33,263,000	27,184,000
12	81.62	-	35,926,000	41,632,000	38,544,000	30,799,000	24,712,000
13	82.68	-	35,926,000	41,632,000	36,362,000	28,518,000	22,466,000
14	83.76	-	35,926,000	41,632,000	34,304,000	26,406,000	20,424,000
15	84.84	-	35,926,000	41,632,000	32,362,000	24,450,000	18,567,000
16	85.93	-	35,926,000	41,632,000	30,531,000	22,639,000	16,879,000
17	87.07	-	35,926,000	41,632,000	28,802,000	20,962,000	15,345,000

Table 4-55: Option 6A Life Cycle Costing (Pula)							
Reference Year	Water Demand (Mm ³)	Capital Cost	Electricity - Pumping Cost	Maintenance Cost	NPV at 6% Discount Rate	NPV at 8% Discount Rate	NPV at 10% Discount Rate
18	88.16	-	35,926,000	41,632,000	27,172,000	19,409,000	13,950,000
19	89.31	-	37,936,000	41,632,000	26,298,000	18,437,000	13,010,000
20	90.43	-	37,936,000	41,632,000	24,810,000	17,071,000	11,827,000
21	91.54	-	37,936,000	41,632,000	23,406,000	15,807,000	10,752,000
22	92.66	-	37,936,000	41,632,000	22,081,000	14,636,000	9,774,700
23	93.05	-	37,936,000	41,632,000	20,831,000	13,552,000	8,886,100
24	94.20	-	37,936,000	41,632,000	19,652,000	12,548,000	8,078,200
25	104.50	-	37,936,000	41,632,000	18,539,000	11,618,000	7,343,900
26	105.77	-	37,936,000	41,632,000	17,490,000	10,758,000	6,676,200
27	107.05	-	37,936,000	41,632,000	16,500,000	9,960,900	6,069,300
28	108.35	-	37,936,000	41,632,000	15,566,000	9,223,100	5,517,600
29	109.67	-	37,936,000	41,632,000	14,685,000	8,539,900	5,016,000
30	113.75	-	37,936,000	41,632,000	13,854,000	7,907,300	4,560,000
31	115.13	-	37,936,000	41,632,000	13,070,000	7,321,600	4,145,400
32	116.53	-	37,936,000	41,632,000	12,330,000	6,779,200	3,768,600
33	117.95	-	37,936,000	41,632,000	11,632,000	6,277,100	3,426,000
34	119.38	-	40,892,000	41,632,000	11,381,000	6,028,000	3,230,200
35	122.97	-	40,892,000	41,632,000	10,737,000	5,581,500	2,936,500
36	124.47	-	40,892,000	41,632,000	10,129,000	5,168,000	2,669,600
37	125.98	-	40,892,000	41,632,000	9,555,700	4,785,200	2,426,900
38	127.51	-	40,892,000	41,632,000	9,014,800	4,430,800	2,206,300
39	129.07	-	40,892,000	41,632,000	8,504,600	4,102,600	2,005,700
40	132.24	-	40,892,000	41,632,000	8,023,200	3,798,700	1,823,400
41	133.85	-	40,892,000	41,632,000	7,569,000	3,517,300	1,657,600
42	135.48	-	40,892,000	41,632,000	7,140,600	3,256,700	1,506,900
43	137.13	-	40,892,000	41,632,000	6,736,400	3,015,500	1,369,900
44	141.48	-	40,892,000	41,632,000	6,355,100	2,792,100	1,245,400
45	143.20	-	40,892,000	41,632,000	5,995,400	2,585,300	1,132,200
46	144.95	-	40,892,000	41,632,000	5,656,000	2,393,800	1,029,200
47	146.71	-	40,892,000	41,632,000	5,335,900	2,216,500	935,670
48	148.50	-	40,892,000	41,632,000	5,033,800	2,052,300	850,610
49	150.72	-	45,824,000	41,632,000	5,032,700	2,013,900	819,500
50	152.56	-	45,824,000	41,632,000	4,747,900	1,864,700	745,000
51	154.42	-	45,824,000	41,632,000	4,479,100	1,726,600	677,280
52	156.30	-	45,824,000	41,632,000	4,225,600	1,598,700	615,710
53	158.21	-	45,824,000	41,632,000	3,986,400	1,480,200	559,730
54	159.97	-	45,824,000	41,632,000	3,760,800	1,370,600	508,850
55	161.94	-	45,824,000	41,632,000	3,547,900	1,269,100	462,590
56	163.93	-	45,824,000	41,632,000	3,347,100	1,175,100	420,530
57	165.94	-	45,824,000	41,632,000	3,157,600	1,088,000	382,300
58	167.98	-	45,824,000	41,632,000	2,978,900	1,007,400	347,550

Table 4-55: Option 6A Life Cycle Costing (Pula)							
Reference Year	Water Demand (Mm ³)	Capital Cost	Electricity - Pumping Cost	Maintenance Cost	NPV at 6% Discount Rate	NPV at 8% Discount Rate	NPV at 10% Discount Rate
59	170.05	-	45,824,000	41,632,000	2,810,300	932,800	315,950
60	172.14	-	45,824,000	41,632,000	2,651,200	863,710	287,230
61	174.26	-	45,824,000	41,632,000	2,501,100	799,730	261,120
62	176.40	-	45,824,000	41,632,000	2,359,500	740,490	237,380
63	178.57	-	45,824,000	41,632,000	2,226,000	685,640	215,800
					8,370,800,000	8,070,400,000	7,884,600,000

4.13 OPTION 6B

Option 6B consists of three pump stations and four break pressure reservoirs on the line. Pump station PS1 is positioned at chainage 8 km at an elevation of 1063.832 m, pump station PS3 is positioned at chainage 228 km at an elevation of 913.484 m and pump station PS2 is positioned at chainage 274 km at an elevation of 1008.819 m. Break pressure reservoir BPT3 is positioned at chainage 22 km at an elevation of 1101.67 m, break pressure reservoir BPT5 is positioned at chainage 228 km at an elevation of 913.484 m, break pressure reservoir BPT4 is positioned at chainage 274 km at an elevation of 1008.819 m and break pressure reservoir BPT2 is positioned at chainage 330 km at an elevation of 1136.405 m. The pipeline follows R2. The MFD illustrating the transfer scheme is provided in **Figure 4-24**. The longitudinal profile of the pipeline together with the position of the pump station and all the reservoirs is illustrated in **Figure 4-25**. The hydraulic grade-line for the option is also illustrated in this figure. The hydraulic system components as sized according to the procedure described in Methodology are summarised **Table 4-56**. The hydraulic calculations are provided electronically in Option 6B.excel sheets on the supporting CD.

Table 4-56: Option 6B Hydraulic Components

Option 6B Summary			
Item	Chainage (km)	Value	
Pipeline	0-8	1.9	m - Diameter
Pump Station	8	50	m - Pumping Head
Pipeline	8-22	1.9	m - Diameter
Break Pressure	22	10	m -Elevation
Pipeline	22-164	1.9	m - Diameter
Pipeline	164-226	1.8	m - Diameter
Pipeline	226-228	2	m - Diameter
Break Pressure	228	10	m - Elevation
Pump Station	228	120	m - Pumping Head
Pipeline	228-274	2	m -Diameter

Option 6B Summary			
Item	Chainage (km)	Value	
Break Pressure	274	10	m - Elevation
Pump Station	274	165	m - Pumping Head
Pipeline	274-330	2	m -Diameter
Break Pressure	330	10	m - Elevation
Pipeline	330-482	1.8	m -Diameter
Pipeline	482-500	1.5	m -Diameter

The capital costs as calculated for the LCCA for Option 6B are provided **Table 4-57** and the calculated maintenance costs are provided in **Table 4-58**. The electricity costs for the option are summarised in **Table 4-59**. The complete life cycle costing calculation is provided in **Table 4-60**. The Net Present Value (NPV) for the option was calculated for the three different discount rates analysed by taking the yearly expenditure back to a 2010 present value. The calculated NPVs are compared in greater detail in Option Comparison. Option 6B's LCCA calculations are provided electronically in Option 6BLCCA excel sheets.

Table 4-57: Option 6B Capital Costs

Option 6B Capital Costs (Pula)	
Pipe Cost	4,900,000,000.00
Pipe Laying and Joining	980,000,000.00
Pipe Trench Excavation & Back Fill	715,000,000.00
Air Valve, Scour Valve & Isolating Cost	314,000,000.00
Pump Station Cost PS 1	28,600,000.00
Pump Station Cost PS 3	53,600,000.00
Pump Station Cost PS 3	67,300,000.00
Reservoir Cost BPT 3	2,600,000.00
Reservoir Cost BPT 5	2,600,000.00
Reservoir Cost BPT 5	2,600,000.00
Reservoir Cost BPT 5	2,600,000.00
Total	7,066,300,000.00

Table 4-58: Option 6B Maintenance Costs

Option 6B Maintenance Costs (Pula)		
Item	Percentage Per Annum	Cost P/year
Civil	0.50%	24,600,000.00
Mechanical & Electrical	4%	15,820,000.00
Total		40,420,000.00

Table 4-59: Option 6B Energy Costs Summary

Pipe Type	Energy Cost Per Year PS 1 (Pula)	Energy Cost Per Year PS 3 (Pula)	Energy Cost Per Year PS 2 (Pula)
New Pipe	12,950,000.00	20,870,000.00	20,870,000.00
Average Pipe	13,660,000.00	22,080,000.00	22,080,000.00
Old Pipe	14,700,000.00	23,840,000.00	23,840,000.00
Biofilm Pipe	16,460,000.00	26,370,000.00	26,362,000.00

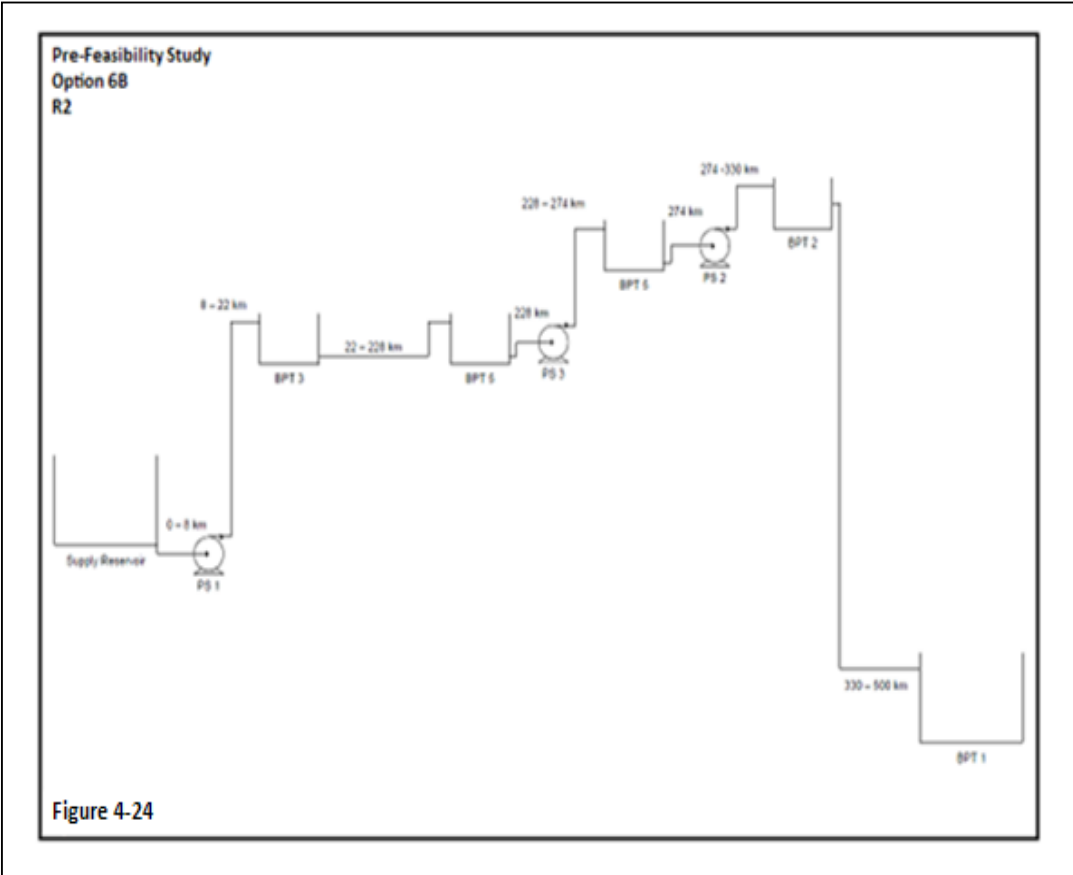

Figure 4-24: Option 6B MFD

Figure 4-25: Option 6B Longitudinal and Energy Profile

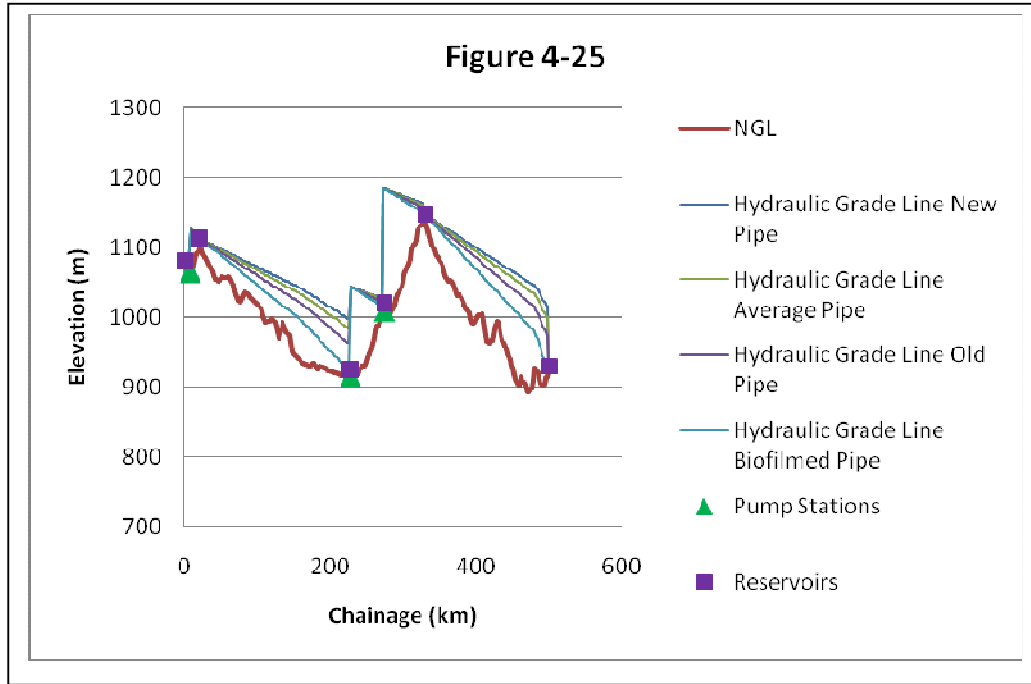

Table 4-60: Option 6B Life Cycle Costing

Table 4-60: Option 6B Life Cycle Costing (Pula)							
Reference Year	Water Demand (Mm ³)	Capital Cost	Electricity - Pumping Cost	Maintenance Cost	NPV at 6% Discount Rate	NPV at 8% Discount Rate	NPV at 10% Discount Rate
0	69.80	1,766,100,000			1,766,100,000	1,766,100,000	1,766,100,000
1	70.66	1,766,100,000			1,766,100,000	1,766,100,000	1,766,100,000
2	71.57	1,766,100,000			1,766,100,000	1,766,100,000	1,766,100,000
3	73.23	1,766,100,000			1,766,100,000	1,766,100,000	1,766,100,000
4	74.19	-	39,969,000	40,324,000	63,599,000	59,017,000	54,841,000
5	74.64	-	39,969,000	40,324,000	59,999,000	54,646,000	49,855,000
6	75.58	-	39,969,000	40,324,000	56,603,000	50,598,000	45,323,000
7	76.56	-	39,969,000	40,324,000	53,399,000	46,850,000	41,203,000
8	77.56	-	39,969,000	40,324,000	50,377,000	43,380,000	37,457,000
9	78.56	-	39,969,000	40,324,000	47,525,000	40,166,000	34,052,000
10	79.58	-	39,969,000	40,324,000	44,835,000	37,191,000	30,956,000
11	80.57	-	39,969,000	40,324,000	42,297,000	34,436,000	28,142,000
12	81.62	-	39,969,000	40,324,000	39,903,000	31,885,000	25,584,000
13	82.68	-	39,969,000	40,324,000	37,644,000	29,523,000	23,258,000
14	83.76	-	39,969,000	40,324,000	35,513,000	27,336,000	21,144,000
15	84.84	-	39,969,000	40,324,000	33,503,000	25,312,000	19,221,000
16	85.93	-	39,969,000	40,324,000	31,607,000	23,437,000	17,474,000

Table 4-60: Option 6B Life Cycle Costing (Pula)							
Reference Year	Water Demand (Mm ³)	Capital Cost	Electricity - Pumping Cost	Maintenance Cost	NPV at 6% Discount Rate	NPV at 8% Discount Rate	NPV at 10% Discount Rate
17	87.07	-	39,969,000	40,324,000	29,818,000	21,701,000	15,885,000
18	88.16	-	39,969,000	40,324,000	28,130,000	20,093,000	14,441,000
19	89.31	-	42,229,000	40,324,000	27,285,000	19,128,000	13,498,000
20	90.43	-	42,229,000	40,324,000	25,740,000	17,711,000	12,271,000
21	91.54	-	42,229,000	40,324,000	24,283,000	16,400,000	11,155,000
22	92.66	-	42,229,000	40,324,000	22,909,000	15,185,000	10,141,000
23	93.05	-	42,229,000	40,324,000	21,612,000	14,060,000	9,219,300
24	94.20	-	42,229,000	40,324,000	20,389,000	13,018,000	8,381,200
25	104.50	-	42,229,000	40,324,000	19,235,000	12,054,000	7,619,300
26	105.77	-	42,229,000	40,324,000	18,146,000	11,161,000	6,926,600
27	107.05	-	42,229,000	40,324,000	17,119,000	10,334,000	6,296,900
28	108.35	-	42,229,000	40,324,000	16,150,000	9,569,000	5,724,500
29	109.67	-	42,229,000	40,324,000	15,236,000	8,860,200	5,204,100
30	113.75	-	42,229,000	40,324,000	14,373,000	8,203,900	4,731,000
31	115.13	-	42,229,000	40,324,000	13,560,000	7,596,200	4,300,900
32	116.53	-	42,229,000	40,324,000	12,792,000	7,033,500	3,909,900
33	117.95	-	42,229,000	40,324,000	12,068,000	6,512,500	3,554,400
34	119.38	-	45,557,000	40,324,000	11,844,000	6,273,200	3,361,600
35	122.97	-	45,557,000	40,324,000	11,174,000	5,808,500	3,056,000
36	124.47	-	45,557,000	40,324,000	10,541,000	5,378,300	2,778,200
37	125.98	-	45,557,000	40,324,000	9,944,400	4,979,900	2,525,600
38	127.51	-	45,557,000	40,324,000	9,381,500	4,611,000	2,296,000
39	129.07	-	45,557,000	40,324,000	8,850,500	4,269,400	2,087,300
40	132.24	-	45,557,000	40,324,000	8,349,500	3,953,200	1,897,500
41	133.85	-	45,557,000	40,324,000	7,876,900	3,660,400	1,725,000
42	135.48	-	45,557,000	40,324,000	7,431,100	3,389,200	1,568,200
43	137.13	-	45,557,000	40,324,000	7,010,400	3,138,200	1,425,600
44	141.48	-	45,557,000	40,324,000	6,613,600	2,905,700	1,296,000
45	143.20	-	45,557,000	40,324,000	6,239,300	2,690,500	1,178,200
46	144.95	-	45,557,000	40,324,000	5,886,100	2,491,200	1,071,100
47	146.71	-	45,557,000	40,324,000	5,552,900	2,306,600	973,730
48	148.50	-	45,557,000	40,324,000	5,238,600	2,135,800	885,210
49	150.72	-	50,673,000	40,324,000	5,236,500	2,095,400	852,680
50	152.56	-	50,673,000	40,324,000	4,940,100	1,940,200	775,160
51	154.42	-	50,673,000	40,324,000	4,660,400	1,796,400	704,690
52	156.30	-	50,673,000	40,324,000	4,396,600	1,663,400	640,630
53	158.21	-	50,673,000	40,324,000	4,147,800	1,540,200	582,390
54	159.97	-	50,673,000	40,324,000	3,913,000	1,426,100	529,450
55	161.94	-	50,673,000	40,324,000	3,691,500	1,320,400	481,310
56	163.93	-	50,673,000	40,324,000	3,482,600	1,222,600	437,560

Table 4-60: Option 6B Life Cycle Costing (Pula)							
Reference Year	Water Demand (Mm ₃)	Capital Cost	Electricity - Pumping Cost	Maintenance Cost	NPV at 6% Discount Rate	NPV at 8% Discount Rate	NPV at 10% Discount Rate
57	165.94	-	50,673,000	40,324,000	3,285,400	1,132,100	397,780
58	167.98	-	50,673,000	40,324,000	3,099,500	1,048,200	361,620
59	170.05	-	50,673,000	40,324,000	2,924,000	970,560	328,740
60	172.14	-	50,673,000	40,324,000	2,758,500	898,670	298,860
61	174.26	-	50,673,000	40,324,000	2,602,400	832,100	271,690
62	176.40	-	50,673,000	40,324,000	2,455,100	770,470	246,990
63	178.57	-	50,673,000	40,324,000	2,316,100	713,390	224,540
					8,176,000,000	7,864,300,000	7,671,600,000

4.14 OPTION COMPARISON

The 12 options analysed in the LCCA can be compared directly utilising their NPVs calculated as all these values were calculated using the same methodology and input values. The options with the lowest NPVs will be the most economical options over the entire project lifetime and therefore the most preferable option. The options are compared graphically in **Figure 4-26** and in tabular format in **Table 4-61**.

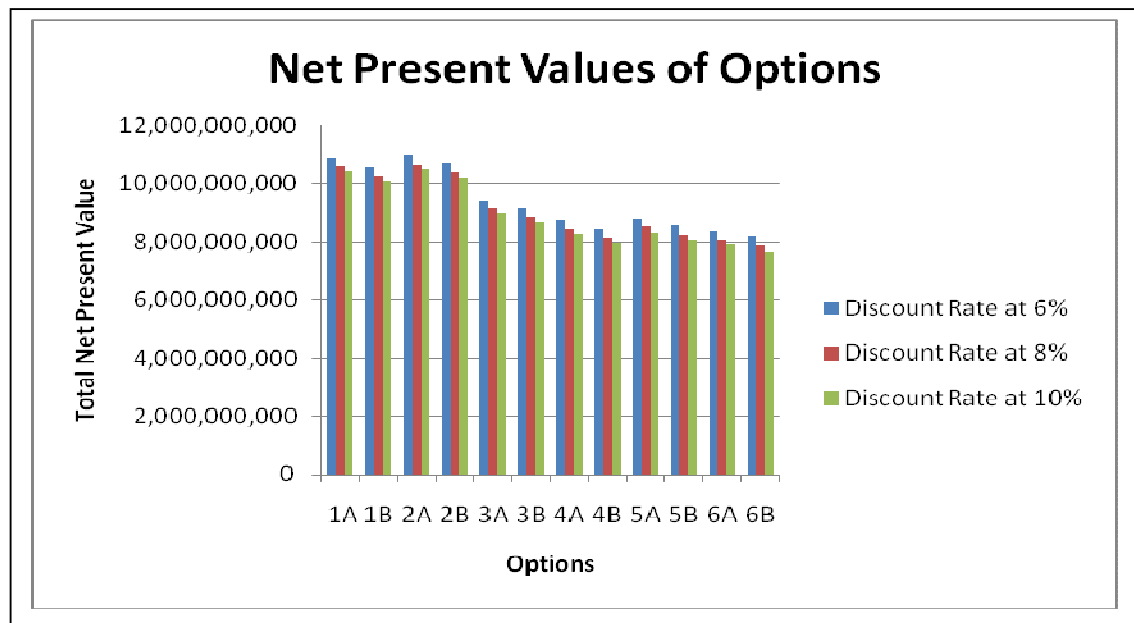

Figure 4-26: Net Present Value Comparison

Table 4-61: Net Present Value Comparison

OPTION	Discount Rate at 6%	Discount Rate at 8%	Discount Rate at 10%
1A	10,903,000,000	10,602,000,000	10,416,000,000
1B	10,572,000,000	10,277,000,000	10,095,000,000
2A	10,994,000,000	10,693,000,000	10,507,000,000
2B	10,697,000,000	10,402,000,000	10,219,000,000
3A	9,447,200,000	9,161,900,000	8,985,200,000
3B	9,140,300,000	8,862,100,000	8,689,700,000
4A	8,758,100,000	8,448,500,000	8,256,900,000
4B	8,445,100,000	8,142,700,000	7,955,600,000
5A	8,823,100,000	8,512,500,000	8,320,400,000
5B	8,557,200,000	8,251,700,000	8,062,800,000
6A	8,370,800,000	8,070,400,000	7,884,600,000
6B	8,176,000,000	7,864,300,000	7,671,600,000

From these comparisons it is noted that the options including break pressure tanks are considerably more economical than those without. This highlights the fact that the comparison of the options is governed by the cost of the construction of the steel pipeline and specifically to the cost of the steel pipeline with regards to its pipe wall thickness as the pipeline extends over a long distance.

The transfer schemes without additional break pressure tanks are easier to operate as the control philosophy for the scheme will be simpler. This system has a single long pipeline though will therefore be more difficult to design especially with regards to the alleviation of excess surge pressures.

The transfer scheme with additional break pressure tanks will be more difficult to operate compared to a scheme without, as additional surge control measures will have to be introduced. The design of the system will be easier as the scheme is split into smaller sections of pipeline.

Together with the lower NPV cost over the life of the transfer scheme and ease of design for the scheme Option 6A and Option 6B are the preferred options. The NPV of Option 6A is higher than that of Option 6B; this is due to the increased cost resulting from the longer pipeline length. Depending on conditions of the pipeline and the necessity of the pipeline to pass Serule, Option 6B is the recommended option and therefore R2 is the recommended route. Option 6B is discussed in greater detail in Option 6B Details and Recommendations.

5. CONCLUSION

5.1 OPTION 6B DETAILS AND RECOMMENDATIONS

The price of the pipeline was the controlling factor in the LCCA therefore the calculation of the pipe wall thickness calculation is discussed. The calculation that was used to calculate the steel pipe wall thickness is provided in Appendix C. The pipe wall thickness was calculated according to the procedures described in Pipeline Design Criteria, which originate from **AWWA M11**. The thickness was determined utilising the Barlow formula provided below.

$$t = \frac{pd}{2s}$$

Where: t = minimum pipe wall thickness for the specified internal design pressure (mm)

p = internal design pressure (kPa)

d = Outside diameter of pipe (mm)

s = Allowable design stress (kPa)

The allowable design stress was taken as the yield strength of steel multiplied by 0.5. If this calculated wall thickness value is less than a D/t ratio (diameter divided by thickness) of 160, a wall thickness resulting from a D/t ratio of 160 was utilised. The internal pressure used in the calculation is the greater pressure of the dynamic pressure and the static pressure within the pipeline section. Surge pressures were not taken into account. These pressures must be taken into consideration when determining the final design pipeline wall thicknesses. It must be ensured that these pipe wall thicknesses are adequate for external loading on the pipe.

Option 6B consists of three pump stations and four break pressure tanks. A control philosophy for this system will be required for the transfer scheme to operate efficiently. A simplified preliminary control philosophy is described below; this control philosophy is to be expanded in further project phases. Each pump station and downstream break pressure reservoir will act independently for the pumping lines and the control of the gravity lines will be at the downstream reservoir. For pumping lines, the pumps will start when the downstream reservoir level reaches 50% of the reservoir capacity; the pumps will stop when the reservoir reaches full capacity level. The gravity pipelines will be controlled by actuated isolation valves at the downstream reservoir, the valve will open when the downstream reservoir level reaches 50% of the reservoir capacity and will close when the reservoir reaches full capacity level.

5.2 FURTHER PROJECT PHASES

The assessment for the need of the scheme to pass Serule needs to be assessed in order to ensure that R2 is the correct option to be chosen.

The option of pumping at higher heads and decreasing the pipe wall thickness must be investigated as further LCCA options in further feasibility studies. Further optimisation calculations must also be investigated by investigating the use of thin walled pipes ($D/t < 160$). External Loading on these pipes must also be assessed and the use of ribs will have to be investigated. The effect of different grades of steel for the pipeline must also be assessed in the further design phases. In the calculations provided in Appendix C it is noted if the minimum pipe wall thickness was utilised or not, in the cases where it was not additional break pressure reservoirs may be constructed or different diameters can be utilised.

6. RECOMMENDATION

It is recommended that **Option 6** be optimised in a detailed feasibility study. Apart from the technical issues discussed above, the economical advantage to construct the pipeline in two or more phases needs to be investigated.

7. APPENDICES

APPENDIX A - BPC TARIFFS

BPC BOTSWANA POWER CORPORATION

ENVIRONMENT **FAQ** NEWS FEEDBACK AIDS POLICY

TARIFFS

Botswana Power Corporation customers are categorised into six classes based on the use and size of supply taken.

Tariff Category (TOU means Type Of User)

(T.O.U.4) Domestic
This category is reserved for supplies used for domestic purposes only. It does not include institutional customers such as Boarding Houses. Common sizes of supply offered are 60 Amps 230 volts and 60 Amps 400 volts, where the security deposit is a standard P400.00. In exceptional cases domestic supplies in excess of 60 Amps 400 volts have been made available.

Security deposits required in such cases are generally higher than for standard supplies. Contact should be made with the Commercial Engineer (Services) of the Corporation for determination of an appropriate value of deposit, which would normally be higher than P 400-00 but lower than P 90.00 per Amp of supply.

Consumers in this category pay a fixed charge plus energy only rates.

(T.O.U.6) Small Business
This category applies to commercial industrial or institutional consumers supplied with electricity not exceeding 60 Amps 400 volts and in respect of loads not exceeding 35 kW. Security Deposits payable by this category of consumer are P 900 for -supplies taken at 230 volts and P 1 870.00 for supplies taken at 400 volts. Similar to the domestic category only fixed and energy charges are applicable.

(T.O.U.7) Medium Business
The category applies to commercial, industrial and institutional customers supplied with electricity not exceeding 400 volts and in respect of loads that exceed 35 kW. Security Deposits are payable at the rate of P 90.00 per Amp of supply. Charges payable monthly for this customer grouping are fixed charge, energy charge and maximum demand charge.

(T.O.U.8) Large Business
This class applies to all business consumers supplied with electricity at or above 11 000 volts. The structure of the rates as well as Security Deposits are as per Business 2 customers.

(T.O.U.2) Government
This category applies to all Government, Municipal and Street Lighting installations, regardless of the size of supply taken or the use to which the supply is put. No Security Deposit is required from this class of customer. Charges applicable are fixed charge and energy charge only

T.O.U.1) Water Pumping
This is a special category reserved for water pumping applications, regardless of the size of supply taken. It is advisable however that where an installation's load factor exceeds 33%, ordinary business tariffs be requested as they tend to be more economic for the customer.

Each tariff grouping has particular rates assigned to it as given in the table below

	Domestic (TOU4)	Small Business (TOU6)	Medium Business (TOU7)	Large Business (TOU8)	Government (TOU2)	Water Pumping (TOU1)
Fixed Charge (Pula per month)	P10.19	P26.09	P26.09	P26.09	P26.09	P26.09

Energy Charge (Pula per kWh)	P0.3670	P0.4017	P0.2060	P0.1857	P0.5206	P0.4096
Demand Charge (Pula per kW per month)	Nil	Nil	P49.31	P46.41	Nil	Nil

Demand Charge - The charge payable shall be calculated from the actual demand supplied or from 90% of the peak demand recorded in the previous 12 months, whichever is the greater.

Disclaimer

Copyright © 2004 - Webmaster

APPENDIX B - LCCA COST ESTIMATES

Air Valve, Scour Valve & Isolating Budget			
Pipe Diameter (mm)	Civil Rate/m	Mechanical Rate/m	Total P/m
500	36.4	63.6	100
600	36.4	72.7	109.1
700	36.4	90.9	127.3
800	36.4	127.3	163.7
900	36.4	172.7	209.1
1000	36.4	227.3	263.7
1100	36.4	327.3	363.7
1200	45.5	418.2	463.7
1300	45.5	436.4	481.9
1400	45.5	454.5	500
1500	45.5	481.8	527.3
1600	54.5	509.1	563.6
1700	54.5	527.3	581.8
1800	54.5	545.5	600
1900	63.6	581.8	645.4
2000	63.6	618.2	681.8
2100	63.6	654.5	718.1
2200	72.7	691	763.7
2300	72.7	700	772.7
2400	81.8	736.4	818.2
2500	81.8	772.7	854.5

Steel Pipe Prices	
Coating Cost Per m ²	P 182
Steel Pipe Cost Per Ton	P 16 000
Steel Pipe Cost Per kg	P 16
Delivery Cost Per m	P 77.3
Laying and Joining 20% of Pipe Price	

Pump Station Costs - DWA 2003 Escalated to 2010	
PS Capacity kW	Cost P/kW
100	27,480.00
200	22,800.00
300	20,400.00
400	18,900.00
500	17,750.00
600	16,900.00
700	16,203.00
800	15,630.00
900	15,140.00
1 000	15,000.00
2 000	12,300.00
3 000	11,000.00
5 000	9,540.00
6 000	9,100.00
7 000	8,710.00
8 000	8,400.00
9 000	8,140.00
10 000	8,000.00
20 000	6,600.00
40 000	5,500.00
50 000	5,140.00
60 000	4,900.00
70 000	4,700.00
80 000	4,600.00
90 000	4,400.00
100 000	4,300.00

Reservoir Costing	
Reservoir (incl. earthworks and lining) per m ³	P 73

Pipe Trench Excavation & Back Fill	
Excavation Cost (P/m ³)	45.5
Bedding and Cradle Fill (P/m ³)	150
Main Fill (P/m ³)	50
Spoil (P/m ³)	42

Appendix C - Option 6B Pipe Wall Thickness Calculation Sheet

Option 12 Pipeline Pricing						
Chainage (km)	Elevation (m)	Section Length (km)	Diameter (m)	Pipe Wall thickness (mm)	Steel Mass (kg)	Pipe Area (m2)
2	1069.018	0	1.9	11.9	0	0.00
4	1067.321	2	1.9	11.9	1105895	11938.05
6	1064.035	2	1.9	11.9	1105895	11938.05
8	1063.832	2	1.9	11.9	1105895	11938.05
10	1067.893	2	1.9	11.9	1105895	11938.05
12	1075.133	2	1.9	11.9	1105895	11938.05
14	1082.768	2	1.9	11.9	1105895	11938.05
16	1089.726	2	1.9	11.9	1105895	11938.05
18	1094.131	2	1.9	11.9	1105895	11938.05
20	1097.897	2	1.9	11.9	1105895	11938.05
22	1101.67	2	1.9	11.9	1105895	11938.05
24	1095.952	2	1.9	11.9	1105895	11938.05
26	1090.107	2	1.9	11.9	1105895	11938.05
28	1085.781	2	1.9	11.9	1105895	11938.05
30	1081.89	2	1.9	11.9	1105895	11938.05
32	1077.937	2	1.9	11.9	1105895	11938.05
34	1074.89	2	1.9	11.9	1105895	11938.05
36	1071.114	2	1.9	11.9	1105895	11938.05
38	1065.311	2	1.9	11.9	1105895	11938.05
40	1059.051	2	1.9	11.9	1105895	11938.05
42	1054.28	2	1.9	11.9	1105895	11938.05
44	1053.871	2	1.9	11.9	1105895	11938.05
46	1050.42	2	1.9	11.9	1105895	11938.05
48	1052.704	2	1.9	11.9	1105895	11938.05
50	1056.355	2	1.9	11.9	1105895	11938.05
52	1058.466	2	1.9	11.9	1105895	11938.05
54	1055.99	2	1.9	11.9	1105895	11938.05
56	1055.66	2	1.9	11.9	1105895	11938.05
58	1056.404	2	1.9	11.9	1105895	11938.05
60	1056.841	2	1.9	11.9	1105895	11938.05
62	1056.377	2	1.9	11.9	1105895	11938.05
64	1052.503	2	1.9	11.9	1105895	11938.05
66	1046.022	2	1.9	11.9	1105895	11938.05
68	1036.575	2	1.9	11.9	1105895	11938.05
70	1031.818	2	1.9	11.9	1105895	11938.05
72	1027.675	2	1.9	11.9	1105895	11938.05
74	1023.844	2	1.9	11.9	1105895	11938.05
76	1020.888	2	1.9	11.9	1105895	11938.05
78	1023.648	2	1.9	11.9	1105895	11938.05
80	1027.566	2	1.9	11.9	1105895	11938.05
82	1032.371	2	1.9	11.9	1105895	11938.05
84	1034.983	2	1.9	11.9	1105895	11938.05

Option 12 Pipeline Pricing						
Chainage (km)	Elevation (m)	Section Length (km)	Diameter (m)	Pipe Wall thickness (mm)	Steel Mass (kg)	Pipe Area (m2)
86	1033.213	2	1.9	11.9	1105895	11938.05
88	1031.188	2	1.9	11.9	1105895	11938.05
90	1029.08	2	1.9	11.9	1105895	11938.05
92	1026.322	2	1.9	11.9	1105895	11938.05
94	1023.207	2	1.9	11.9	1105895	11938.05
96	1021.503	2	1.9	11.9	1105895	11938.05
98	1019.765	2	1.9	11.9	1105895	11938.05
100	1018.493	2	1.9	11.9	1105895	11938.05
102	1016.444	2	1.9	11.9	1105895	11938.05
104	1013.288	2	1.9	11.9	1105895	11938.05
106	1007.843	2	1.9	11.9	1105895	11938.05
108	1001.282	2	1.9	11.9	1105895	11938.05
110	996.609	2	1.9	11.9	1105895	11938.05
112	992.999	2	1.9	11.9	1105895	11938.05
114	993.639	2	1.9	11.9	1105895	11938.05
116	994.611	2	1.9	11.9	1105895	11938.05
118	995.751	2	1.9	11.9	1105895	11938.05
120	996.479	2	1.9	11.9	1105895	11938.05
122	996.147	2	1.9	11.9	1105895	11938.05
124	992.094	2	1.9	11.9	1105895	11938.05
126	985.623	2	1.9	11.9	1105895	11938.05
128	977.759	2	1.9	11.9	1105895	11938.05
130	969.772	2	1.9	11.9	1105895	11938.05
132	981.785	2	1.9	11.9	1105895	11938.05
134	991.458	2	1.9	11.9	1105895	11938.05
136	987.77	2	1.9	11.9	1105895	11938.05
138	982.725	2	1.9	11.9	1105895	11938.05
140	977.559	2	1.9	11.9	1105895	11938.05
142	975.289	2	1.9	11.9	1105895	11938.05
144	973.968	2	1.9	11.9	1105895	11938.05
146	962.473	2	1.9	11.9	1105895	11938.05
148	951.285	2	1.9	11.9	1105895	11938.05
150	948.174	2	1.9	11.9	1105895	11938.05
152	944.641	2	1.9	11.9	1105895	11938.05
154	941.566	2	1.9	11.9	1105895	11938.05
156	940.942	2	1.9	11.9	1105895	11938.05
158	939.726	2	1.9	11.9	1105895	11938.05
160	936.738	2	1.9	11.9	1105895	11938.05
162	933.65	2	1.9	11.9	1105895	11938.05
164	932.745	2	1.8	11.3	992548	11309.73
166	931.696	2	1.8	11.3	992548	11309.73
168	930.999	2	1.8	11.3	992548	11309.73

Option 12 Pipeline Pricing						
Chainage (km)	Elevation (m)	Section Length (km)	Diameter (m)	Pipe Wall thickness (mm)	Steel Mass (kg)	Pipe Area (m ²)
170	930.885	2	1.8	11.3	992548	11309.73
172	930.378	2	1.8	11.3	992548	11309.73
174	931.324	2	1.8	11.3	992548	11309.73
176	933.53	2	1.8	11.3	992548	11309.73
178	932.714	2	1.8	11.3	992548	11309.73
180	928.311	2	1.8	11.3	992548	11309.73
182	924.179	2	1.8	11.3	992548	11309.73
184	928.398	2	1.8	11.3	992548	11309.73
186	930.866	2	1.8	11.3	992548	11309.73
188	928.411	2	1.8	11.3	992548	11309.73
190	927.849	2	1.8	11.3	992548	11309.73
192	926.71	2	1.8	11.3	992548	11309.73
194	926.201	2	1.8	11.3	992548	11309.73
196	924.509	2	1.8	11.3	992548	11309.73
198	923.417	2	1.8	11.3	996509	11309.73
200	923.011	2	1.8	11.3	998645	11309.73
202	921.969	2	1.8	11.4	1004125	11309.73
204	920.661	2	1.8	11.5	1011005	11309.73
206	920.243	2	1.8	11.5	1013203	11309.73
208	919.297	2	1.8	11.5	1018178	11309.73
210	917.533	2	1.8	11.6	1027453	11309.73
212	917.684	2	1.8	11.6	1026659	11309.73
214	915.724	2	1.8	11.8	1036964	11309.73
216	915.73	2	1.8	11.8	1036933	11309.73
218	915.584	2	1.8	11.8	1037700	11309.73
220	915.444	2	1.8	11.8	1038436	11309.73
222	913.52	2	1.8	11.9	1048550	11309.73
224	912.524	2	1.8	11.9	1053786	11309.73
226	912.565	2	2	13.3	1300704	12566.37
228	913.484	2	2	12.5	1225368	12566.37
230	913.545	2	2	12.5	1225368	12566.37
232	914.546	2	2	12.5	1225368	12566.37
234	918.285	2	2	12.5	1225368	12566.37
236	919.357	2	2	12.5	1225368	12566.37
238	918.649	2	2	12.5	1225368	12566.37
240	922.974	2	2	12.5	1225368	12566.37
242	927.375	2	2	12.5	1225368	12566.37
244	929.253	2	2	12.5	1225368	12566.37
246	930.863	2	2	12.5	1225368	12566.37
248	931.924	2	2	12.5	1225368	12566.37
250	936.722	2	2	12.5	1225368	12566.37
252	941.777	2	2	12.5	1225368	12566.37

Option 12 Pipeline Pricing						
Chainage (km)	Elevation (m)	Section Length (km)	Diameter (m)	Pipe Wall thickness (mm)	Steel Mass (kg)	Pipe Area (m ²)
254	948.143	2	2	12.5	1225368	12566.37
256	955.417	2	2	12.5	1225368	12566.37
258	962.7	2	2	12.5	1225368	12566.37
260	969.281	2	2	12.5	1225368	12566.37
262	980.284	2	2	12.5	1225368	12566.37
264	986.551	2	2	12.5	1225368	12566.37
266	989.198	2	2	12.5	1225368	12566.37
268	994.39	2	2	12.5	1225368	12566.37
270	999.917	2	2	12.5	1225368	12566.37
272	1004.623	2	2	12.5	1225368	12566.37
274	1008.819	2	2	12.5	1225368	12566.37
276	1007.834	2	2	12.5	1225368	12566.37
278	1005.626	2	2	12.5	1225368	12566.37
280	1001.623	2	2	12.5	1225368	12566.37
282	1004.052	2	2	12.5	1225368	12566.37
284	1010.797	2	2	12.5	1225368	12566.37
286	1014.67	2	2	12.5	1225368	12566.37
288	1017.319	2	2	12.5	1225368	12566.37
290	1027.459	2	2	12.5	1225368	12566.37
292	1031.99	2	2	12.5	1225368	12566.37
294	1036.254	2	2	12.5	1225368	12566.37
296	1040.127	2	2	12.5	1225368	12566.37
298	1044.396	2	2	12.5	1225368	12566.37
300	1051.339	2	2	12.5	1225368	12566.37
302	1060.955	2	2	12.5	1225368	12566.37
304	1070.227	2	2	12.5	1225368	12566.37
306	1072.691	2	2	12.5	1225368	12566.37
308	1076.503	2	2	12.5	1225368	12566.37
310	1083.996	2	2	12.5	1225368	12566.37
312	1097.188	2	2	12.5	1225368	12566.37
314	1103.545	2	2	12.5	1225368	12566.37
316	1105.174	2	2	12.5	1225368	12566.37
318	1111.657	2	2	12.5	1225368	12566.37
320	1122.935	2	2	12.5	1225368	12566.37
322	1128.197	2	2	12.5	1225368	12566.37
324	1132.561	2	2	12.5	1225368	12566.37
326	1131.854	2	2	12.5	1225368	12566.37
328	1133.338	2	2	12.5	1225368	12566.37
330	1136.405	2	1.8	11.3	992548	11309.73
332	1128.709	2	1.8	11.3	992548	11309.73
334	1120.713	2	1.8	11.3	992548	11309.73
336	1115.226	2	1.8	11.3	992548	11309.73

Option 12 Pipeline Pricing						
Chainage (km)	Elevation (m)	Section Length (km)	Diameter (m)	Pipe Wall thickness (mm)	Steel Mass (kg)	Pipe Area (m2)
338	1108.709	2	1.8	11.3	992548	11309.73
340	1102.499	2	1.8	11.3	992548	11309.73
342	1096.349	2	1.8	11.3	992548	11309.73
344	1090.39	2	1.8	11.3	992548	11309.73
346	1087.765	2	1.8	11.3	992548	11309.73
348	1084.661	2	1.8	11.3	992548	11309.73
350	1081.662	2	1.8	11.3	992548	11309.73
352	1076.872	2	1.8	11.3	992548	11309.73
354	1070.898	2	1.8	11.3	992548	11309.73
356	1065.018	2	1.8	11.3	992548	11309.73
358	1059.58	2	1.8	11.3	992548	11309.73
360	1055.284	2	1.8	11.3	992548	11309.73
362	1050.886	2	1.8	11.3	992548	11309.73
364	1052.647	2	1.8	11.3	992548	11309.73
366	1051.117	2	1.8	11.3	992548	11309.73
368	1048.266	2	1.8	11.3	992548	11309.73
370	1040.172	2	1.8	11.3	992548	11309.73
372	1033.483	2	1.8	11.3	992548	11309.73
374	1030.95	2	1.8	11.3	992548	11309.73
376	1032.263	2	1.8	11.3	992548	11309.73
378	1031.391	2	1.8	11.3	992548	11309.73
380	1025.791	2	1.8	11.3	992548	11309.73
382	1020.911	2	1.8	11.3	992548	11309.73
384	1015.65	2	1.8	11.3	992548	11309.73
386	1012.139	2	1.8	11.3	992548	11309.73
388	1010.472	2	1.8	11.3	992548	11309.73
390	1005.401	2	1.8	11.3	992548	11309.73
392	996.666	2	1.8	11.3	992548	11309.73
394	991.35	2	1.8	11.3	992548	11309.73
396	990.486	2	1.8	11.3	992548	11309.73
398	992.761	2	1.8	11.3	992548	11309.73
400	999.077	2	1.8	11.3	992548	11309.73
402	1001.8	2	1.8	11.3	992548	11309.73
404	1002.224	2	1.8	11.3	992548	11309.73
406	1002.003	2	1.8	11.3	992548	11309.73
408	1003.596	2	1.8	11.3	992548	11309.73
410	994.111	2	1.8	11.3	992548	11309.73
412	983.925	2	1.8	11.3	992548	11309.73
414	972.347	2	1.8	11.3	992548	11309.73
416	963.901	2	1.8	11.3	992548	11309.73
418	963.258	2	1.8	11.3	992548	11309.73
420	965.872	2	1.8	11.3	992548	11309.73

Option 12 Pipeline Pricing						
Chainage (km)	Elevation (m)	Section Length (km)	Diameter (m)	Pipe Wall thickness (mm)	Steel Mass (kg)	Pipe Area (m2)
422	966.177	2	1.8	11.3	992548	11309.73
424	973.825	2	1.8	11.3	992548	11309.73
426	983.972	2	1.8	11.3	992548	11309.73
428	994.096	2	1.8	11.3	992548	11309.73
430	991.695	2	1.8	11.3	992548	11309.73
432	984.933	2	1.8	11.3	992548	11309.73
434	974.509	2	1.8	11.3	992548	11309.73
436	966.698	2	1.8	11.3	992548	11309.73
438	963.618	2	1.8	11.3	992548	11309.73
440	957.803	2	1.8	11.3	998345	11309.73
442	954.277	2	1.8	11.5	1016889	11309.73
444	947.182	2	1.8	12.0	1054190	11309.73
446	938.045	2	1.8	12.5	1102201	11309.73
448	930.871	2	1.8	12.9	1139876	11309.73
450	926.391	2	1.8	13.2	1163394	11309.73
452	918.344	2	1.8	13.7	1205619	11309.73
454	911.505	2	1.8	14.1	1241488	11309.73
456	903.61	2	1.8	14.6	1282874	11309.73
458	900.63	2	1.8	14.7	1298489	11309.73
460	904.066	2	1.8	14.5	1280484	11309.73
462	915.092	2	1.8	13.9	1222677	11309.73
464	905.556	2	1.8	14.5	1272675	11309.73
466	905.271	2	1.8	14.5	1274168	11309.73
468	901.918	2	1.8	14.7	1291740	11309.73
470	895.651	2	1.8	15.0	1324573	11309.73
472	892.304	2	1.8	15.2	1342102	11309.73
474	895.279	2	1.8	15.1	1326521	11309.73
476	896.818	2	1.8	15.0	1318460	11309.73
478	909.921	2	1.8	14.2	1249793	11309.73
480	926.295	2	1.8	13.2	1163898	11309.73
482	924.888	2	1.5	11.1	813391	9424.78
484	919.044	2	1.5	11.4	834685	9424.78
486	911.164	2	1.5	11.8	863386	9424.78
488	903.893	2	1.5	12.1	889855	9424.78
490	901.953	2	1.5	12.2	896915	9424.78
492	900.198	2	1.5	12.3	903301	9424.78
494	904.177	2	1.5	12.1	888821	9424.78
496	912.253	2	1.5	11.7	859420	9424.78
498	915.297	2	1.5	11.6	848335	9424.78
500	919.629	2	1.5	9.4	689270	9424.78